



# **McGowan Fence & Supply Limited**

811 Progress Avenue  
Scarborough, Ontario M1H 2X4  
Tel (416)431-5556 Fax (416)431-2595

## **2018 CATALOGUE** **All Products and Price List**

**QUALITY**  
**and**  
*Service*

**Since 1948**

## **TERMS AND CONDITIONS**

ALL PRICES, EXCEPT THOSE LISTED AS NET, ARE SUBJECT TO YOUR DEALER DISCOUNT. (TO CONFIRM DISCOUNT LEVEL, PLEASE PHONE)

ALL PRICES ARE C.O.D. UNLESS PRIOR CREDIT ARRANGEMENTS HAVE BEEN ESTABLISHED. PAYMENT BY CASH, APPROVED CHEQUE, DEBIT CARD, VISA, OR MASTER CARD.

ALL PRICES ARE F.O.B. OUR YARD, 811 PROGRESS AVE. SCARBOROUGH, ONTARIO M1H 2X4. DELIVERIES TO BE ARRANGED.

THE H.S.T. SALES TAX (IF APPLICABLE) IS EXTRA TO ALL CATALOGUE PRICES.

**PRICES AND SPECIFICATIONS SUBJECT TO CHANGE WITHOUT NOTICE.**

Illustrations reprinted with permission of Metro Fence & Fittings Ltd.

# Table of Contents – Complete Catalogue

## Residential Section (R)

Residential Fence Kits - 10' Centers .....	R-1
Residential Fence Kits - 8' Centers .....	R-2
End Post Kits .....	R-3
Corner Post Kits .....	R-3
Gates .....	R-3
Residential Double Gates .....	R-4
Gate Frames .....	R-4
Residential Galvalume Tubing .....	R-4
Coloured Residential Tubing - Posts and Rail .....	R-5
Coloured Fittings .....	R-5
Coloured Gates .....	R-6
Coloured Gate Frames .....	R-6
Coloured Gate Hardware .....	R-6
Chain Link Fabrics per Foot .....	R-7
Galvanized .....	R-7
Vinyl Coated .....	R-7
Chain Link Fabrics per Roll .....	R-8
Galvanized .....	R-8
Vinyl Coated .....	R-8
Residential Chain Link Fence Fittings .....	R-9
Tension Bands .....	R-9
Brace Bands .....	R-9
Rail Ends .....	R-9
Post Caps .....	R-9
Tension Bars .....	R-9
Line Post Caps .....	R-9
Tie Wires .....	R-10
Bolts and Nuts .....	R-10
Bottom Wire .....	R-10
Bottom Wire Clips .....	R-10
Galvanized Gate Clips .....	R-10
Residential Chain Link Gate Hardware .....	R-11
Post Collars .....	R-11
Spring Closures .....	R-11
Frame Collars .....	R-11
Hinge Bolts .....	R-11
Finger Latches .....	R-11
Latch Catches .....	R-11
Cane Bolts .....	R-11

## Industrial Section (I)

Industrial Fence Kits - Spec #2 .....	I-1
End Posts .....	I-1
Corner Posts .....	I-1
Industrial Fence Kits - Spec #3 .....	I-2
End Posts .....	I-2
Corner Posts .....	I-2
Chain Link Fabrics per Foot .....	I-3
Galvanized .....	I-3
Vinyl Coated .....	I-3
Chain Link Fabrics per Roll .....	I-4
Galvanized .....	I-4
Vinyl Coated .....	I-4
Galvanized Pipe .....	I-5
Schedule 40 .....	I-5
Light Wall .....	I-5
Industrial Chain Link Swing Gates .....	I-6
Industrial Chain Link Fence Fittings .....	I-7
Tension Bands .....	I-7
Brace Bands .....	I-7
Rail Ends .....	I-7
Post Caps .....	I-7
Line Post Caps .....	I-7
Tension Bars .....	I-8
Gate Caps .....	I-8
Sleeves .....	I-8
Boulevard Clamps .....	I-8
Tie Wires .....	I-9
Bolts and Nuts .....	I-9
Bottom Wire .....	I-9
Bottom Wire Clips .....	I-9
Eye Bolts and Brackets .....	I-9
Turnbuckles .....	I-9
Sleeve Anchors .....	I-9
Overhang Barbed Wire Arms .....	I-10
Vertical Barbed Wire Arms .....	I-10
Corner Barbed Wire Arms .....	I-10
Industrial Chain Link Gate Hardware .....	I-11
Post Collars .....	I-11
Spring Closures .....	I-11
Frame Collars .....	I-11
Hinge Bolts .....	I-11
Latch Catches .....	I-12
Drop Latches .....	I-12
Wall Latch .....	I-12
Gate Chain Hold Opens .....	I-12
Cane Bolts .....	I-12
Centre Rests .....	I-12
Galvanized Chain .....	I-12

**Misc. Section (M)**

Welded Wire Fabric.....M-1  
Barbed Wire .....M-1  
Staples .....M-1  
Pre-Galvanized Flex Beam Guard Rail.....M-1  
Farm Fence.....M-2  
Farm Gates.....M-2  
Merchant Wire .....M-3  
Quik Rok .....M-3  
Painted Steel T-Posts and Clips .....M-3  
Vexar Plastic Fence.....M-4  
Snow Fence Ties.....M-4  
Dog Kennels.....M-5

**Ornamental Section (O)**

Iron Eagle Tradition - Residential ..... O-1  
Residential Two Rail system ..... O-1  
Residential Three Rail system ..... O-1  
Posts..... O-1  
Iron Eagle 2000 Series - Residential..... O-2  
Residential Two Rail system ..... O-2  
Residential Three Rail system ..... O-2  
Posts..... O-2  
Iron Eagle Residential Fittings ..... O-3  
Iron Eagle II - Industrial ..... O-6  
Industrial Two Rail system ..... O-6  
Industrial Three Rail system ..... O-6  
Posts..... O-6  
Iron Eagle Industrial Fittings ..... O-7

## Residential Fence Kits – 10 Foot Centers - Per Foot Price

All per foot prices of our fence kits include the following:

**Line posts spaced every 10 ft.** with linepost caps, top rail in 10 ft. sections (swedged), chain link fabric, bottom wire and tie wires.

Height and Mesh Size	Galvanized Frame		Coloured Frame
	Galv. Fabric	Vinyl Fabric	Vinyl Fabric
<b>2" Mesh - 9ga.</b>  36" High 42" High 48" High 60" High 72" High		4.81 5.17 5.53 6.40 7.66	5.62 5.99 6.35 7.26 8.56
<b>1½" Mesh - 11ga.</b>  36" High 42" High 48" High 60" High 72" High		On Request On Request 6.03 7.03 8.41	On Request On Request 6.85 7.89 9.31
<b>1½" Mesh - 9ga.</b>  36" High 42" High 48" High 60" High 72" High		On Request On Request 6.79 7.98 9.55	On Request On Request 7.61 8.84 10.45
<b>2¼" Mesh - 11ga.</b>  48" High 60" High 72" High	5.56 6.44 7.70		

Vinyl frame and fabric available in green, white, black or brown.

## Residential Fence Kits – 8 Foot Centers - Per Foot Price

All per foot prices of our fence kits include the following:

**Line posts spaced every 8 ft.** with linepost caps, top rail in 10 ft. sections (swedged), chain link fabric, bottom wire and tie wires.

Note: Residential fencing with 8 ft. centers may be required for pool enclosures in your area. Check your municipal bylaws for the exact legal requirements.

Height and Mesh Size	Galvanized Frame		Coloured Frame
	Galv. Fabric	Vinyl Fabric	Vinyl Fabric
<b>2" Mesh - 9ga.</b>  36" High 42" High 48" High 60" High 72" High		5.09 5.45 5.82 6.72 8.11	6.00 6.36 6.72 7.68 9.12
<b>1½" Mesh - 11ga.</b>  36" High 42" High 48" High 60" High 72" High		On Request On Request 6.32 7.34 8.86	On Request On Request 7.22 8.31 9.87
<b>1½" Mesh - 9ga.</b>  36" High 42" High 48" High 60" High 72" High		On Request On Request 7.08 8.30 10.00	On Request On Request 7.98 9.26 11.02
<b>2¼" Mesh - 11ga.</b>  48" High 60" High 72" High	5.85 6.76 8.15		

Vinyl frame and fabric available in green, white, black or brown.

## Residential Fence Kits - End or Corner Posts; Gates

### Residential End Post Kits

All end post kits include 1 post, 1 $\frac{1}{8}$ " O.D. (2 $\frac{3}{8}$ " O.D. for 6 ft. fence). Length to suit fence height, complete with post cap, rail end and brace band, tension bands, tension bar and bolts and nuts.

Fence Height	Galvanized	Coloured
36", 42" or 48" High Fence	21.32	29.17
60" High Fence	24.75	33.94
72" High Fence	32.68	43.65

### Residential Corner Post Kits

All corner posts include 1 post, as above, but 2 complete sets of fittings.

Fence Height	Galvanized	Coloured
36", 42" or 48" High Fence	29.46	41.75
60" High Fence	34.51	49.01
72" High Fence	44.10	61.30

### Residential Gates

Unit prices are for 2 pc. gate frame 1 $\frac{1}{4}$ " O.D. tubing complete with chain link infill and all necessary latching and hinging hardware for 1 $\frac{7}{8}$ " O.D. post.

1 $\frac{7}{8}$ " spring closures are extra @ \$25.30 ea.

Upgrade to 2 $\frac{3}{8}$ " O.D. hardware extra @ \$3.61 per set (includes 2 $\frac{3}{8}$ " post collars and latch catch)

Gate Height	3 Ft. Wide	3 $\frac{1}{2}$ Ft. Wide	4 Ft. Wide	5 Ft. Wide	6 Ft. Wide
36" High	116.63	116.63	118.00		
42" High	116.63	116.63	118.00		
48" High	116.63	116.63	118.00	136.22	143.46
60" High	122.01	122.01	124.02	138.12	
72" High	126.66	126.66	130.44		

## Residential Double Gates

2 pc. Frame 1¼" O.D. Tubing, complete with chain link infill and all necessary latching and hinging hardware.

	Width				
	6'	7'	8'	10'	12'
Height	1- 7/8" Fittings			2-3/8" Fittings	
36"	256.05	256.05	258.79		
42"	256.05	256.05	258.79		
48"	256.05	256.05	258.79	298.01	312.49
60"	266.82	266.82	270.85	301.81	
72"	276.12	276.12	283.68		

## Residential Gate Frames

Unit prices are for 2 pc. gate frame 1¼" O.D. galvalume tubing only. (No infill or hardware included.)

Gate Height	3 Ft. Wide	3½ Ft. Wide	4 Ft. Wide	5 Ft. Wide
36" High	27.42	27.42	27.59	
42" High	27.42	27.42	27.59	
48" High	27.42	27.42	27.59	33.94
60" High	30.16	30.16	30.86	36.67
72" High	32.06	32.06	34.55	

## Residential Galvalume Tubing - Posts, Top Rail and Gate Extensions - Price Each

Size	Description	Gauge	Length	#/Bdle	Loose	Bundle Lot
1-¼"	Toprail	17 ga.	10'4"	91	14.22	12.93
1-½"	Line Post	17 ga.	6'6"	61	10.22	9.29
1-½"	Line Post	17 ga.	7'6"	61	11.80	10.73
1-7/8"	Main Post	17 ga.	6'6"	61	12.94	11.76
1-7/8"	Main Post	17 ga.	7'6"	61	14.91	13.56
1-7/8"	Main Post	17 ga.	8'6"	61	16.92	15.38
2-3/8"	Main Post	17 ga.	8'6"	37	21.58	19.62
1-¼"	Gate Extensions	17 ga.	54"	-	6.76	-
1-¼"	Gate Extensions	17 ga.	66"	91	10.29	9.80



## Coloured Residential Tubing – Posts, Top Rail and Gate Extensions

Available in Green, White, Black, Brown

Size	Description	Gauge	Length	Price Each
1-¼"	Toprail	17 ga.	10'3"	19.23
1-½"	Line Post	17 ga.	6'6"	13.51
1-½"	Line Post	17 ga.	7'6"	15.59
1-⅞"	Main Post	17 ga.	6'6"	16.19
1-⅞"	Main Post	17 ga.	7'6"	18.70
1-⅞"	Main Post	17 ga.	8'6"	21.19
2-⅜"	Main Post	17 ga.	8'6"	26.10
1-¼"	Gate Extensions - Double Swedged	17 ga.	66"	13.59

## Coloured Residential Fittings

Description	Size	Price Each
Line Post Caps	1-½"	1.83
	1-⅞"	2.50
Main Post Caps	1-⅞"	1.87
	2-⅜"	2.27
Tension Bands w/bolt and nut	1-⅞"	1.05
	2-⅜"	1.23
Brace Bands w/bolt and nut	1-⅞"	1.05
	2-⅜"	1.23
Rail Ends	1-¼"	1.62
Tension Bars	36"	4.48
	42"	5.23
	48"	5.97
	60"	7.47
	72"	8.96
Tie Wires	11 ga.	.10
	9 ga.	.15
Bottom Wire	9 ga.	.22/ft.

**Coloured Residential Gates** – Includes chain link infill and fittings for 1-7/8" posts for 48" and 60" high gates and 2-3/8" fittings for 72" high gates

Size	Price Each
3-1/2' x 48"	142.48
3-1/2' x 60"	153.19
3-1/2' x 72"	163.69

**Coloured Residential Gate Frames** – (No infill or hardware included.)

Size	Price Each
4' x 48" high	38.84
4' x 60" high	43.23
4' x 72" high	47.63

**Coloured Residential Gate Hardware**

Description	Price Each
Post collars – 1-7/8"	6.63
Post collars – 2-3/8"	7.73
Frame collars – 1-1/4"	4.43
Finger latches – 1-1/4"	15.79
Latch catches – 1-1/4"	9.33
Latch catches – 1-7/8"	7.86
Latch catches – 2-3/8"	10.00
Wall latch w/mounting plate and sleeve anchors	15.05
Flipper latch only	8.22
Spring closures – 1-7/8" x 1-1/4"	30.57
Spring closures – 2-3/8" x 1-1/4"	31.30
Cane Bolt – 1/2" x 24" w/frame collars	21.07
Gate clips – 1-1/4"	.75

**Chain Link Fabrics** – per foot price, weights per 100 feet

**Galvanized**

Fence Height	2"- 6ga.	Wgt.	2"- 9ga.	Wgt.	2 ¼"- 11ga.	Wgt.	1½"- 9ga.	Wgt.
3'			3.28	183				
3-½'			3.82	214				
4'	9.70	474	4.37	244	3.21	150	7.38	364
5'	12.13	592	5.46	305	4.02	186	9.23	454
6'	14.56	710	6.55	366	4.82	226	11.07	544
7'	16.98	828	7.64	427			12.92	636
8'	19.41	946	8.73	488			14.76	726
10'	24.26	1182	10.92	610			18.46	908
12'	29.11	1418	13.10	732			22.15	1090

**Vinyl Coated** – green, white, black, brown

Fence Height	2"- 6ga.	Wgt.	2"- 9ga.	Wgt.	2"- 11ga.	Wgt.	1½"- 9ga.	Wgt.	1½"- 11ga.	Wgt.
3'			2.39	106	<b>Not</b>	68				100
3-½'			2.78	126	<b>A</b>	86				116
4'	6.99	286	3.18	144	<b>Stock</b>	98	4.57	210	3.73	132
5'	8.74	384	3.98	176	<b>Item</b>	124	5.71	264	4.66	166
6'	10.48	440	4.77	214		142	6.85	320	5.60	200
7'	12.23	536	5.57	252			8.00	374		
8'	13.98	592	6.36	314			9.14	420	<b>1¾"- 9ga.</b>	
10'	17.47	782	7.95	392			11.42	528	10.86	464
12'	20.96	938	9.54	470			13.71	640	13.04	560

**Chain Link Fabrics** – prices per 50 foot roll

**Aluminum Fabric**  
 - prices available on request-

**Galvanized**

Fence Height	2"- 6ga.	2"- 9ga.	2 ¼"- 11ga.	1-½"- 9ga.
3'		148.88		
3-½'		173.70		
4'	441.07	195.51	146.05	335.55
5'	551.34	248.14	182.57	419.43
6'	661.61	297.76	219.08	503.32
7'	771.87	347.39		587.21
8'	882.14	397.02		671.09
10'	1,102.68	496.27		838.87
12'	1,323.21	595.53		1,006.64

**Vinyl Coated** – green, white, black, brown

Fence Height	2"- 6ga.	2"- 9ga.	2"- 11ga.	1-½"- 9ga.	1-½"- 11ga.
3'		108.43			
3-½'		126.50			
4'	317.64	144.57		207.69	169.62
5'	397.05	180.71		259.61	212.02
6'	476.46	216.85		311.53	254.42
7'	555.87	252.99			
8'	635.28	289.13		415.38	<b>1 ¾" - 9 ga.</b>
10'	794.10	361.42		519.22	493.77
12'	952.92	433.70		623.06	592.52

Wire Selvage



Knuckle Top

## Residential Chain Link Fence Fittings

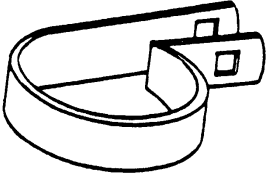
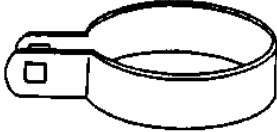
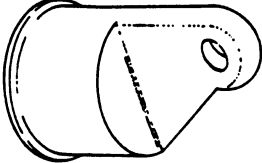
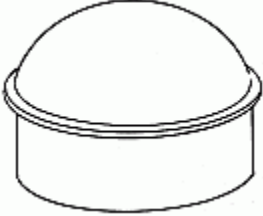
Tension Bands (with bolt and nut)	Size	Price each	Brace Bands (with bolt and nut)	Size	Price each
		1 <sup>7</sup> / <sub>8</sub> "		.63	
	2 <sup>3</sup> / <sub>8</sub> "	.73		2 <sup>3</sup> / <sub>8</sub> "	.73
Rail Ends	Size	Price each	Post Caps	Size	Price each
	1 <sup>1</sup> / <sub>4</sub> "	1.03		1 <sup>7</sup> / <sub>8</sub> "	1.43
				2 <sup>3</sup> / <sub>8</sub> "	1.63

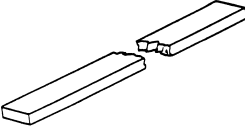
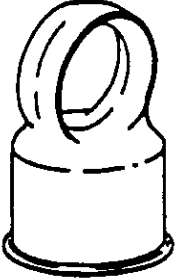
Tension Bars	Size	Price each	Line Post Caps	Size	Price each
		1/2" Steel			
	36"	3.16		1-1/2"	1.23
	42"	3.68		1-7/8" x 1-5/16"	1.79
	48"	4.21			
	60"	5.26			
	72"	6.31			

**Residential Chain Link Fence Fittings (cont'd)**

<b>Description</b>	<b>Size</b>	<b>Quantity</b>	<b>Price each</b>
<b>Tie Wires</b>	11ga. x 6 ½" aluminum	Each	.10
		Per 100	9.90
	11ga. x 6 ½" vinyl	Each	.10
		Per 100	9.26
<b>Bolts and Nuts</b>	5/16" x 1¼"	Each	.20
		Per 100	18.88
<b>Bottom Wire</b>	9ga. galvanized	Per foot	.15
		Per 50lb. coil	147.40
	9ga. vinyl	Per foot	.22
		Per 50lb. coil	213.51
<b>Bottom Wire Clips</b>		Per box of 1000	76.33
<b>Galvanized Gate Clips</b>		Each	.33

## Residential Chain Link Gate Hardware

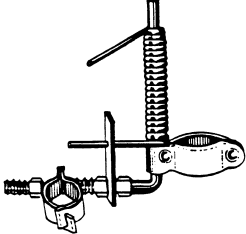
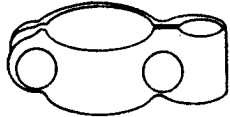
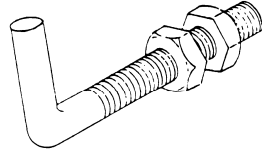
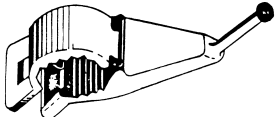
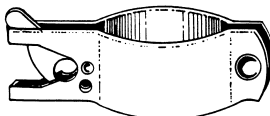
Residential Post Collars	Size	Price each
	Pressed Steel	
	1 $\frac{7}{8}$ " x 1 $\frac{1}{2}$ " w/ bolt	3.77
	2 $\frac{3}{8}$ " x 1 $\frac{1}{2}$ " w/ bolt	4.47
<b>Residential Spring Closures</b> 		
	1 $\frac{7}{8}$ "	25.30
	2 $\frac{3}{8}$ "	26.03
<b>Residential Frame Collars</b> 		
	1 $\frac{1}{4}$ "	1.96
<b>Residential Hinge Bolts</b> 		
	1 $\frac{1}{2}$ " x 3" w/nuts	2.17
	1 $\frac{1}{2}$ " x 3" lag	2.59
	1 $\frac{1}{2}$ " x 7" w/nuts	4.25
<b>Residential Finger Latches</b> 		
	1 $\frac{1}{4}$ "	14.51
<b>Residential Latch Catches</b> 		
	1 $\frac{1}{4}$ "	8.23
	1 $\frac{7}{8}$ "	6.59
	2 $\frac{3}{8}$ "	8.82
Wall Latch w/mounting plate	w/sleeve anchors	13.77
Flipper latch only		7.24
Residential Cane Bolts	1 $\frac{1}{2}$ " x 24" w/brackets	21.16

## Industrial Fence Kits – Spec #2

Includes 2- $\frac{3}{8}$ " O.D. lineposts and caps or overhang barbarm (10' O.C.), 1- $\frac{11}{16}$ " O.D. top rail with sleeves, 2" x 9ga. galvanized chain link fabric (1.2 oz.), 9 ga. bottom wire and 9 ga. aluminum ties. For vertical barbarm add .11/ft.

Fence Height	.100 Wall		Schedule 40	
	FFH	+Barb	FFH	+Barb
48"	9.03		10.93	
60"	10.34		12.40	
72"	11.65	12.50	13.86	14.71
96"	14.27	15.12	16.80	17.65
120"	16.89	17.74	19.74	20.59

**End Posts** – includes 3- $\frac{1}{2}$ " O.D. post with cap, 1 tension bar, tension bands, brace band and rail end.

Fence Height	.125 Wall		Schedule 40	
	FFH	+Barb	FFH	+Barb
48"	59.83		91.56	
60"	67.97		103.93	
72"	75.27	83.97	115.47	128.40
96"	91.55	100.25	140.21	153.14
120"	108.68	117.37	165.79	178.72

**Corner Posts** – includes 3- $\frac{1}{2}$ " O.D. post with cap, 2 tension bar, tension bands, brace bands and rail ends.

Fence Height	.125 Wall		Schedule 40	
	FFH	+Barb	FFH	+Barb
48"	70.19		101.92	
60"	80.29		116.25	
72"	88.72	99.93	128.91	144.36
96"	108.91	120.13	157.57	173.02
120"	130.79	142.01	187.91	203.36

Extra Terminal Post Braces @ 27.83 for .100 wall or 36.07 or Schedule 40.



### Industrial Fence Kits – Spec #3

Includes 1-7/8" O.D. lineposts and caps or overhang barbarm (10' O.C.), 1-5/16" O.D. top rail with sleeves, 2" x 9ga. galvanized chain link fabric (1.2 oz.), 9 ga. bottom wire and 9 ga. aluminum ties.

Fence Height	.100 Wall		Schedule 40	
	FFH	+Barb	FFH	+Barb
48"	8.03		9.27	
60"	9.27		10.62	
72"	10.52	11.19	11.97	12.64
96"	13.00	13.68	14.66	15.34
120"	15.49	16.17	17.36	18.03

**End Posts** – includes 2-3/8" O.D. post with cap, 1 tension bar, tension bands, brace band and rail end.

Fence Height	.100 Wall		Schedule 40	
	FFH	+Barb	FFH	+Barb
48"	36.23		48.80	
60"	41.37		55.62	
72"	45.83	51.21	61.75	68.81
96"	56.11	61.49	75.38	82.44
120"	67.07	72.45	89.69	96.75

**Corner Posts** – includes 2-3/8" O.D. post with cap, 2 tension bar, tension bands, brace bands and rail ends.

Fence Height	.100 Wall		Schedule 40	
	FFH	+Barb	FFH	+Barb
48"	45.80		58.37	
60"	52.74		66.99	
72"	58.32	65.75	74.24	83.34
96"	72.20	79.62	91.47	100.57
120"	87.44	94.87	110.07	119.17

Extra Terminal Post Braces @ 27.67 for .100 wall or 35.91 for Schedule 40.

**Chain Link Fabrics** – per foot price, weights per 100 feet

**Galvanized**

Fence Height	2"- 6ga.	Wgt.	2"- 9ga.	Wgt.	2¼" – 11ga.	Wgt.	1½"- 9ga.	Wgt.
3'			3.28	183				
3-½'			3.82	214				
4'	9.70	474	4.37	244	3.21	150	7.38	364
5'	12.13	592	5.46	305	4.02	186	9.23	454
6'	14.56	710	6.55	366	4.82	226	11.07	544
7'	16.98	828	7.64	427			12.92	636
8'	19.41	946	8.73	488			14.76	726
10'	24.26	1182	10.92	610			18.46	908
12'	29.11	1418	13.10	732			22.15	1090

**Vinyl Coated** – green, white, black, brown

Fence Height	2"- 6ga.	Wgt.	2"- 9ga.	Wgt.	2"- 11ga.	Wgt.	1½"- 9ga.	Wgt.	1½"- 11ga.	Wgt.
3'			2.39	106	<b>Not</b>	68				100
3-½'			2.78	126	<b>A</b>	86				116
4'	6.99	286	3.18	144	<b>Stock</b>	98	4.57	210	3.73	132
5'	8.74	384	3.98	176	<b>Item</b>	124	5.71	264	4.66	166
6'	10.48	440	4.77	214		142	6.85	320	5.60	200
7'	12.23	536	5.57	252			8.00	374		
8'	13.98	592	6.36	314			9.14	420	<b>1¾"- 9ga.</b>	
10'	17.47	782	7.95	392			11.42	528	10.86	464
12'	20.96	938	9.54	470			13.71	640	13.04	560

**Chain Link Fabrics** – prices per 50 foot roll

**Aluminum Fabric**  
 - prices available on request-

**Galvanized**

Fence Height	2"- 6ga.	2"- 9ga.	2¼" – 11ga.	1-½"- 9ga.
3'		148.88		
3-½'		173.70		
4'	441.07	195.51	146.05	335.55
5'	551.34	248.14	182.57	419.43
6'	661.61	297.76	219.08	503.32
7'	771.87	347.39		587.21
8'	882.14	397.02		671.09
10'	1,102.68	496.27		838.87
12'	1,323.21	595.53		1,006.64

**Vinyl Coated** – green, white, black, brown

Fence Height	2"- 6ga.	2"- 9ga.	2"- 11ga.	1-½"- 9ga.	1-½"- 11ga.
3'		108.43			
3-½'		126.50			
4'	317.64	144.57		207.69	169.62
5'	397.05	180.71		259.61	212.02
6'	476.46	216.85		311.53	254.42
7'	555.87	252.99			
8'	635.28	289.13		415.38	<b>1 ¾" - 9 ga.</b>
10'	794.10	361.42		519.22	493.77
12'	952.92	433.70		623.06	592.52

Wire Selvage



Knuckle Top



Barbed Top

## Galvanized Pipe – plain ends

### Schedule 40

O.D. Size	Wall Thickness	Weight per 100'	Price		
			Per Foot	Per 100'	Per 21'
1- <sup>5</sup> / <sub>16</sub> "	.133	169 lbs.	2.55	232.14	48.75
1- <sup>11</sup> / <sub>16</sub> "	.140	227 lbs.	3.43	311.81	65.48
1- <sup>7</sup> / <sub>8</sub> "	.145	272 lbs.	4.11	373.62	78.46
2- <sup>3</sup> / <sub>8</sub> "	.154	365 lbs.	5.52	501.36	105.29
2- <sup>7</sup> / <sub>8</sub> "	.203	579 lbs.	8.75	795.31	167.02
3- <sup>1</sup> / <sub>2</sub> "	.216	758 lbs.	11.45	1,041.19	218.65
4- <sup>1</sup> / <sub>2</sub> "	.237	1079 lbs.	16.30	1,482.11	311.24
6- <sup>5</sup> / <sub>8</sub> "	.280	1897 lbs.	28.66	2,605.72	547.20

### Light Wall

O.D. Size	Wall Thickness	Weight per 100'	Price		
			Per Foot	Per 100'	Per 21'
1- <sup>5</sup> / <sub>16</sub> "	.100	130 lbs.	1.96	178.57	37.50
1- <sup>11</sup> / <sub>16</sub> "	.100	167 lbs.	2.52	229.39	48.17
1- <sup>7</sup> / <sub>8</sub> "	.100	192 lbs.	2.90	263.73	55.38
2- <sup>3</sup> / <sub>8</sub> "	.100	243 lbs.	3.67	333.78	70.09
2- <sup>7</sup> / <sub>8</sub> "	.125	367 lbs.	5.55	504.11	105.86
3- <sup>1</sup> / <sub>2</sub> "	.125	450 lbs.	6.80	618.12	129.81

## Industrial Chain Link Swing Gates - .100 Wall Hot Dip Galvanized Frame

Includes 3-½" O.D. hardware (2 sets of gate hinges), 2" x 9ga. Galvanized fill and 1 11/16" O.D. x .100 wall hot dip galvanized frame, F.F.H. or B.W.O.

	Width					
Height	4'	5'	6'	7'	8'	9'
3'	499.22	525.08	604.02	616.23	633.44	644.81
4'	499.22	525.08	604.02	616.23	633.44	644.81
5'	499.22	525.08	604.02	616.23	633.44	644.81
6'	525.08	538.15	616.23	630.04	643.05	656.15
7'	538.50	558.12	630.04	643.05	656.18	671.83
8'	558.12	565.22	643.05	656.18	885.23	882.18
9'	565.22	578.52	656.18	668.78	917.47	937.69
10'	578.52	591.88	668.78	681.70	998.28	1,026.20
11'	591.88	610.23	681.70	702.94	1,012.59	1,056.37
12'	610.23	618.53	702.94	834.26	1,054.11	1,101.08
	Width					
Height	10'	11'	12'	13'	14'	15'
3'	656.18	681.04	705.91	799.62	893.32	1,043.33
4'	656.18	681.04	705.91	799.62	893.32	1,043.33
5'	656.18	681.04	705.91	799.62	893.32	1,043.33
6'	669.24	738.92	808.60	925.97	1,043.33	1,083.47
7'	687.48	760.87	834.26	958.87	1,083.47	1,123.13
8'	879.13	981.21	1,083.29	1,186.96	1,290.62	1,334.90
9'	957.90	1,035.62	1,113.35	1,224.12	1,334.90	1,386.24
10'	1,054.11	1,087.03	1,119.94	1,253.09	1,386.24	1,434.07
11'	1,100.15	1,148.77	1,197.39	1,315.73	1,434.07	1,496.19
12'	1,148.05	1,197.14	1,246.22	1,371.21	1,496.19	1,544.57

Upgrade to 4 ½" gate hinge set (2 sets of gate hinges) – 20.01      Extra 4 ½" gate hinge set – 39.24  
 Upgrade to 4 ½" latch catch – 16.59      Extra 3 ½" gate hinge set – 29.23

Note: gate hinge set includes 1 post collar, 1 frame collar and 1 hinge bolt

Prices for other size gates, schedule 40 pipe frame, aluminum pipe frame, overhead sliding gates, cantilever gates and all related hardware available on request.

## Industrial Chain Link Fence Fittings

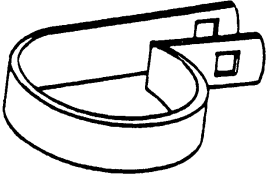
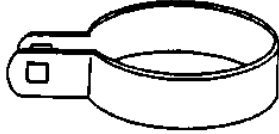
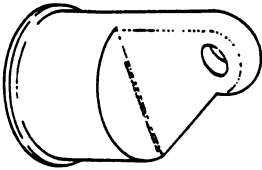
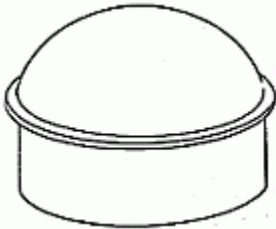
Tension Bands (with bolt and nut)	Size	Price each	Brace Bands (with bolt and nut)	Size	Price each
		1 <sup>5</sup> / <sub>16</sub> "		.62	
	1 <sup>11</sup> / <sub>16</sub> "	.63		1 <sup>11</sup> / <sub>16</sub> "	.64
	1 <sup>7</sup> / <sub>8</sub> "	.63		1 <sup>7</sup> / <sub>8</sub> "	.63
	2 <sup>3</sup> / <sub>8</sub> "	.73		2 <sup>3</sup> / <sub>8</sub> "	.73
	2 <sup>7</sup> / <sub>8</sub> "	.81		2 <sup>7</sup> / <sub>8</sub> "	.81
	3 <sup>1</sup> / <sub>2</sub> "	.89		3 <sup>1</sup> / <sub>2</sub> "	.89
	4 <sup>1</sup> / <sub>2</sub> "	1.36		4 <sup>1</sup> / <sub>2</sub> "	1.36
	6 <sup>5</sup> / <sub>8</sub> "	3.87		6 <sup>5</sup> / <sub>8</sub> "	3.87
Rail End	Size	Price each	Post Cap	Size	Price each
	1 <sup>1</sup> / <sub>4</sub> "	1.03		1 <sup>7</sup> / <sub>8</sub> "	1.43
	1 <sup>5</sup> / <sub>16</sub> "	1.38		2 <sup>3</sup> / <sub>8</sub> "	1.63
	1 <sup>11</sup> / <sub>16</sub> "	1.69		2 <sup>7</sup> / <sub>8</sub> "	2.55
				3 <sup>1</sup> / <sub>2</sub> "	3.11
				4 <sup>1</sup> / <sub>2</sub> "	6.00
				6 <sup>5</sup> / <sub>8</sub> "	23.38

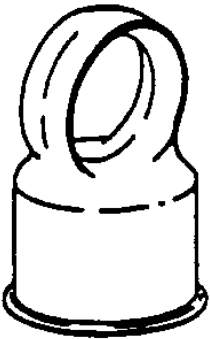
Line Post Caps	Size	Price each
	1- <sup>1</sup> / <sub>2</sub> " x 1- <sup>5</sup> / <sub>16</sub> "	1.23
	1- <sup>5</sup> / <sub>8</sub> "	1.17
	1- <sup>11</sup> / <sub>16</sub> " x 1- <sup>5</sup> / <sub>16</sub> "	1.78
	1- <sup>11</sup> / <sub>16</sub> " x 1- <sup>11</sup> / <sub>16</sub> "	2.25
	1- <sup>7</sup> / <sub>8</sub> " x 1- <sup>5</sup> / <sub>16</sub> "	1.79
	1- <sup>7</sup> / <sub>8</sub> " x 1- <sup>11</sup> / <sub>16</sub> "	1.93
	2- <sup>3</sup> / <sub>8</sub> " x 1- <sup>11</sup> / <sub>16</sub> "	2.19
	2- <sup>7</sup> / <sub>8</sub> " x 1- <sup>11</sup> / <sub>16</sub> " STEEL	8.05
	2- <sup>3</sup> / <sub>8</sub> " Top Wire Cap (MTO)	3.05

**Industrial Chain Link Fence Fittings (cont'd)**

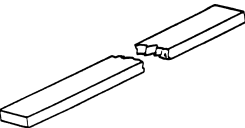
Tension Bars 	Size	Price each	Size	Price each
		<sup>1</sup> / <sub>2</sub> " Steel		<sup>3</sup> / <sub>4</sub> " Steel
	36"	3.16	36"	3.36
	42"	3.68	42"	3.92
	48"	4.21	48"	4.48
	60"	5.26	60"	5.60
	72"	6.31	72"	6.72

Gate Caps 	Size	Price each
		1 <sup>5</sup> / <sub>16</sub> "
	1 <sup>11</sup> / <sub>16</sub> "	1.79

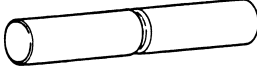

Sleeves 	Size	Price each
		1 <sup>1</sup> / <sub>4</sub> "
	1 <sup>5</sup> / <sub>16</sub> "	2.09
	1 <sup>11</sup> / <sub>16</sub> "	2.34

Boulevard Clamps 	Size	Price each
		1 <sup>7</sup> / <sub>8</sub> " x 1 <sup>5</sup> / <sub>16</sub> "
	2 <sup>3</sup> / <sub>8</sub> " x 1 <sup>11</sup> / <sub>16</sub> "	4.13
	2 <sup>7</sup> / <sub>8</sub> " x 1 <sup>11</sup> / <sub>16</sub> "	4.65

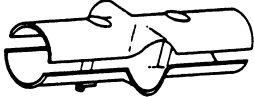
**Industrial Chain Link Fence Fittings (cont'd)**

Description	Size		Price each
<b>Tie Wires</b>	11ga. x 6½" aluminum or vinyl	Each	.10
		Per 100	9.90
	9ga. x 8¼" aluminum or vinyl	Each	.15
		Per 100	13.86
	9ga. x 9½" aluminum or vinyl	Each	.15
		Per 100	13.25
	9ga. X 12" aluminum	Per 100	39.75
<b>Bolts and Nuts</b>	5/16" x 1¼"	Each	.20
		Per 100	18.88
<b>Bottom Wire</b>	9ga. galvanized	Per foot	.15
		Per 50lb. coil	147.40
	9ga. vinyl	Per foot	.22
		Per 50lb. coil	213.51
	6ga. galvanized	Per foot	.32
		Per 50lb. coil	156.08
	6ga. vinyl	Per foot	.50
		Per 50lb. coil	247.45
<b>Bottom Wire Clips</b>		Each	.10
		Per box of 1000	76.33
<b>Misc. Hardware</b>	Eye bolt w/nut		1.78
	Eye bolt bracket		4.03
<b>Turnbuckles</b> 	5/16" x 4" 3/8" x 6"		5.79
			9.13
<b>Sleeve anchors</b>	3/8" x 1 7/8"		.80
	1/2" x 2 1/4"		.84

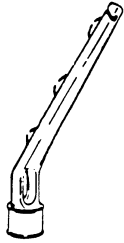

**Industrial Chain Link Fence Fittings (cont'd)**

Overhang Barbed Wire Arms	Size	Price each
	1 <sup>7</sup> / <sub>8</sub> " steel	5.08
	2 <sup>3</sup> / <sub>8</sub> " steel *	5.17
	2 <sup>3</sup> / <sub>8</sub> " aluminum	7.16
	2 <sup>7</sup> / <sub>8</sub> " steel	8.55
	T-Post	10.21
	Double 2 <sup>3</sup> / <sub>8</sub> " steel	On request

Vertical Barbed Wire Arms	Size	Price each
	1 <sup>7</sup> / <sub>8</sub> " steel *	On request
	2 <sup>3</sup> / <sub>8</sub> " steel *	6.35
	2 <sup>3</sup> / <sub>8</sub> " aluminum	11.03

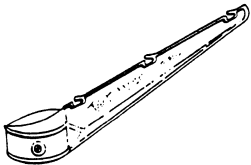
Corner Barbed Wire Arms	Size	Price each
	2 <sup>7</sup> / <sub>8</sub> " aluminum	21.46
	3 <sup>1</sup> / <sub>2</sub> " aluminum	24.34

Note: items with an \* are non-stock

**Industrial Chain Link Gate Hardware**

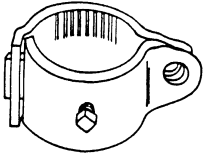
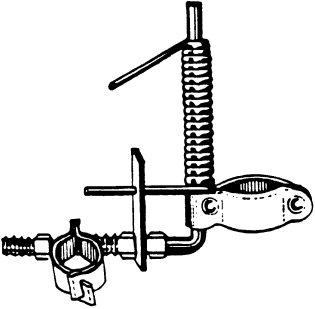
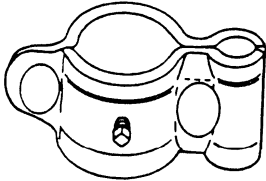
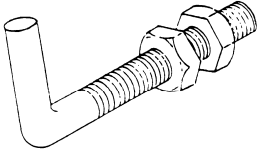
<b>Industrial Post Collars with Set Screw</b>  	<b>Size</b>	<b>Price each</b>
	<b>Pressed Steel</b>	
	2 <sup>3</sup> / <sub>8</sub> " x 3/4" w/o bolt (light)	11.18
	2 <sup>7</sup> / <sub>8</sub> " x 3/4" w/o bolt (light)	11.72
	3 <sup>1</sup> / <sub>2</sub> " x 3/4" w/o bolt (light)	11.38
	4 <sup>1</sup> / <sub>2</sub> " x 3/4" w/o bolt (heavy)	21.38
6 <sup>5</sup> / <sub>8</sub> " x 1" w/o bolt (heavy)	85.29	
<b>Industrial Spring Closures</b>  		
	without post or frame collar	67.59
<b>Industrial Frame Collars with Bolts, Nuts and Set Screw</b>  	<b>Industrial</b>	
	1 <sup>5</sup> / <sub>16</sub> " x 3/4" (light)	7.66
	1 <sup>11</sup> / <sub>16</sub> " x 3/4" (light)	9.90
	1 <sup>7</sup> / <sub>8</sub> " x 3/4" (malleable)	38.36
	<b>Wicket</b>	
	1 <sup>5</sup> / <sub>16</sub> " x 3/4"	16.43
1 <sup>11</sup> / <sub>16</sub> " x 3/4"	18.74	
<b>Industrial Hinge Bolts with Nuts</b>  		
	3/4" x 6" shoulder w/nuts	7.95
	3/4" x 8" w/nuts	10.83
	3/4" x 12" w/nuts and washers	8.11
	1" x 9" w/nuts	39.57

**Industrial Chain Link Gate Hardware (cont'd)**

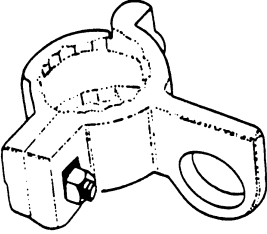
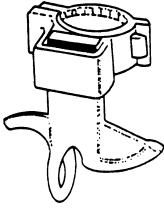
<b>Industrial Latch Catch</b>	<b>Size</b>	<b>Price each</b>
	1 <sup>5</sup> / <sub>16</sub> "	31.70
	1 <sup>11</sup> / <sub>16</sub> "	28.39
	1 <sup>7</sup> / <sub>8</sub> "	40.89
	2 <sup>3</sup> / <sub>8</sub> "	42.11
	2 <sup>7</sup> / <sub>8</sub> "	49.82
	3 <sup>1</sup> / <sub>2</sub> "	49.44
	4 <sup>1</sup> / <sub>2</sub> "	66.04
	6 <sup>5</sup> / <sub>8</sub> "	76.79
<b>Industrial Drop Latch</b>		
	1 <sup>5</sup> / <sub>16</sub> "	58.90
	1 <sup>11</sup> / <sub>16</sub> "	52.97
	1 <sup>7</sup> / <sub>8</sub> "	78.57
<b>Misc. Gate Hardware</b>	<b>Size</b>	<b>Price each</b>
Wall latch		50.50
Gate chain hold opens w/center band	Galvanized	11.48
Cane bolts	¾" x 36" w/brackets	36.84
Centre rest	with pipe	52.56
	w/o pipe	43.19
Galvanized chain	1/8"	1.95/ft.
	3/16"	2.85/ft.
	5/16" Grade 30	8.00/ft.

### Standard Specifications for Industrial Chain Link Fence

Spec. #	Gauge	Mesh	Terminal Posts O.D.	Intermediate Posts O.D.	Top Rail O.D.	Full Fabric Height or including Barb Wire Overhang	Recommended Applications
1	6	2"	3½"	2¾"	1 <sup>11</sup> / <sub>16</sub> "	FFH or BWO	Heavy Industrial
2	9	2"	3½"	2¾"	1 <sup>11</sup> / <sub>16</sub> "	FFH or BWO	Industrial or Commercial
3	9	2"	2¾"	1¾"	1 <sup>5</sup> / <sub>16</sub> "	FFH or BWO	Light Industrial or Commercial
4	9	1½"	3½"	2¾"	1 <sup>11</sup> / <sub>16</sub> "	FFH or BWO	Industrial or Commercial including Tennis Courts

### Metric Conversion

Pipe Sizes	Fence Height	Wire Gauge	Common Metric Conversions Table	
			Convert	multiply by
1 <sup>5</sup> / <sub>16</sub> " = 33.44mm	4' = 1.2m	6ga. = 5.0mm	metres to feet	3.2808
1 <sup>11</sup> / <sub>16</sub> " = 42.2mm	5' = 1.5m	9ga. = 3.5mm	mm to inches	0.0394
1 <sup>7</sup> / <sub>8</sub> " = 48.3mm	6' = 1.8m	11ga. = 3.0mm	kg to pounds	2.2046
2 <sup>3</sup> / <sub>8</sub> " = 60.3mm	7' = 2.1m		feet to metres	0.3048
2 <sup>7</sup> / <sub>8</sub> " = 73.0mm	8' = 2.4m	Mesh Size	inches to mm	25.4003
3 <sup>1</sup> / <sub>2</sub> " = 88.9mm	10' = 3.0m	1½" = 38.1mm	pounds to kg	0.4536
4 <sup>1</sup> / <sub>2</sub> " = 114.3mm	12' = 3.6m	1¾" = 44.5mm		
6 <sup>5</sup> / <sub>8</sub> " = 168.3mm		2" = 50.8mm		

### Holes per Cubic Metre of Concrete

Depth	Diameter					
	6"	8"	10"	12"	16"	18"
36"	59.5	33.5	21.5	15.0	8.5	6.6
42"	51.1	28.7	18.3	12.7	7.2	5.7
48"	44.7	25.2	16.1	11.2	6.2	4.9
54"	39.8	22.4	14.3	9.9	5.6	4.4

1 cubic metre is approx. equal to 1.31 cubic yards

**Welded Wire Fabric** – standard galvanized – prices per 100' roll

Gauge	Mesh	Weight/100 sq. ft.	36"	48"	60"
16	1" X 1"	26lbs.	274.50	356.40	269.76
12	2" X 2"	35lbs.		318.41	398.60
10	2" X 2"	53lbs.		596.49	738.27

These are standard stock items. Prices on other sizes and gauges available on request.

**Barbed Wire** – 80 rod spools only (1320')

Type	Style number	Price per spool
4 point 5" x 15½ ga. Double Strand	Class 3, Hi-tensile	100.28

**Staples** – farm 1¼" galvanized, barbed

Description	Price each
Per 50 lb. box (approx. 2600 pcs.)	97.68

**Pre-Galvanized Flex Beam Guard Rail**

Description	Size	Price each
Guard rail – 12ga.	12'6"	150.00
Terminal section – 12ga.		79.13
Pressure treated Jackpine posts	8" x 8" x 7'4"	106.88
Pressure treated Jackpine blocks	8" x 8" x 15"	19.95

**Farm Fence – Hi Tensile Class 3 Galvanized**

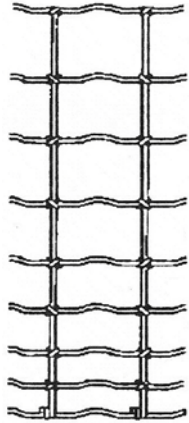
Style		Weight	Roll Size	Price	
8x42-12-12½	Fixed Knot	110 lbs.	20 rod (330 ft.)	283.50	
8x42-12-12½	Fixed Knot	220 lbs.	40 rod (660 ft.)	521.96	
9x49-12-12½	Fixed Knot	130 lbs.	20 rod (330 ft.)	322.26	
9x49-12-12½	Fixed Knot	260 lbs.	40 rod (660 ft.)	620.99	
The graphic image to the right shows a 9x49-12-12½ style farm fence. 9 is the number of <b>horizontal</b> line wires, 49 is the overall height in inches, 12 is the pull-out or distance, in inches, of the <b>vertical</b> stay wires and 12½ is the wire gauge. Notice that the <b>horizontal</b> line wires are spaced closer together at the bottom to prevent small animals from passing through.					
A rod is equivalent to 16.5 feet or 5.0292 metres. There are 320 rods in a mile.					

**Farm Gates – with hold back chain, hinge bolts and washers**

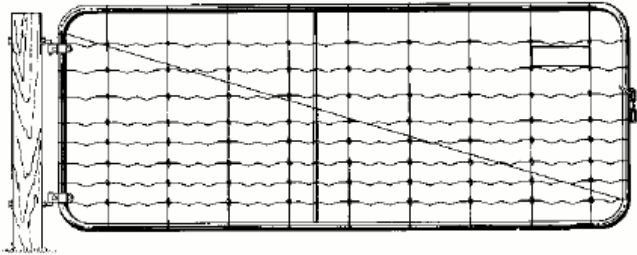
Part Number	Description	Price	
FG10	10' x 48"	257.52	
FG12	12' x 48"	276.44	
FG14	14' x 48"	352.76	
FG16	16' x 48"	376.20	
FG18	18' x 48"	424.08	

Note: Gates up to 16' come with two sets of hinges. 18' gates come with three sets.

**Merchant Wire** – available in 10lb. and 50lb. coils

Gauge	Price per 10lb.	# ft. per 10lb. coil	Price per 50lb.	# ft. per 50lb. coil
9ga.	19.67	180 ft/coil	85.71	903 ft/coil
12ga.	20.07	346 ft/coil	95.54	1731 ft/coil
14ga.	20.07	585 ft/coil	85.41	2926 ft/coil
16ga.	16.53	914 ft/coil	n/a	n/a

**Quik Rok** – fast set cement, per 50lb. pail

Net price each				
1-9 pails	10-49 pails	50-99 pails	100+pails	
68.25	61.19	56.48	54.13	

**Painted steel T-Posts** – punched

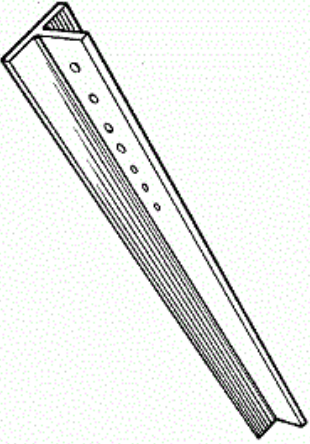
Length	Weight per 100	# in a bundle	Price each		
			Loose	Bundle lot	
<b>Standard weight</b>					
6'	798lbs.	50	9.97	9.07	
7'	931lbs.	50	11.70	10.64	
8'	1064lbs.	50	13.44	12.22	
9'	1197lbs.	50	On Request		
10'	1330lbs.	50	On Request		
<b>Light weight</b>					
6'	678lbs.	50	8.88	8.08	
7'	791lbs.	50	10.61	9.65	
8'	904lbs.	50	12.06	10.97	

**Vexar Plastic Fence** – 100% Canadian made from recycled resins!

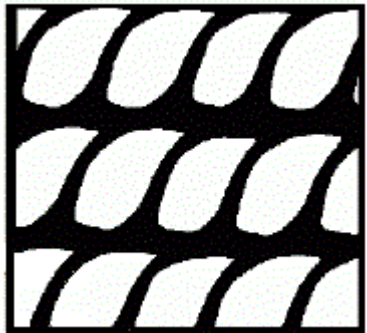

Description	Net price per roll			
	1-9 rolls	10-24 rolls	25+ rolls	
<b>L60 Safety Fence</b> International Orange 1½" mesh x 48" 50' rolls, 26lbs. per roll	60.24	57.73	55.22	 L60/L70 Safety Fence
<b>L70 Safety Fence/Residential Fence</b> Orange/Green/Black 2" mesh x 48" 50' rolls, 20lbs. per roll	37.32	35.77	34.21	
<b>L250 Snow Fence</b> International Orange 48" high 50' rolls, 26lbs. per roll	80.40	77.05	73.70	 L250 Snow Fence

**Snow Fence Ties - Galvanized**

Size	Weight of bundle	Price per bundle
10" x 14ga.	46lbs	73.98

Description	Price	
T-Post Plastic Caps	.55	 <small>T-Cap</small>



## Dog Kennels – Pre-Galvanized Tubing

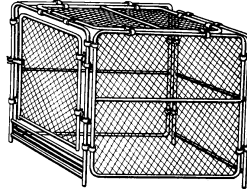

**No welding, No drilling holes, Nothing to install!**

Manufactured from 1¼" O.D. x 16ga. **Pre-Galvanized tubing**. 2" x 11ga. galvanized fill, including 2 double frame collars per panel. Roof panels come with 8 double frame collars.

Front panels with gate (w x h)		Back panels (w x h)	
Size	Price each	Size	Price each
4' x 72"	291.47	4' x 72"	160.19
6' x 72"	362.16	6' x 72"	177.42
8' x 72"	412.70	8' x 72"	197.25
		10' x 72"	228.63
		12' x 72"	274.35
<b>Side panels (l x h)</b>		<b>Roof panels (w x l)</b>	
6' x 72"	177.42	4' x 72"	160.19
8' x 72"	197.25	6' x 72"	177.42
10' x 72"	228.63	6' x 96"	197.34
12' x 72"	274.35	6' x 120"	227.05
		6' x 144"	270.34
<b>Fittings</b>			
Double frame collars (MF 39)	1.75	Kennel Latch	9.76
		Gate Hinges	4.31
3 Way Clamp	2.17		

48" and 60" heights are also available. Other custom sizes are available upon request.

**Iron Eagle Tradition** – available in black, white, brown, green. ½" x ½" pickets, 1" x1" rails - (includes universal brackets)

**Residential Two Rail system** – Elegant Eagle, Imperial Eagle, Majestic Eagle, Royal Eagle

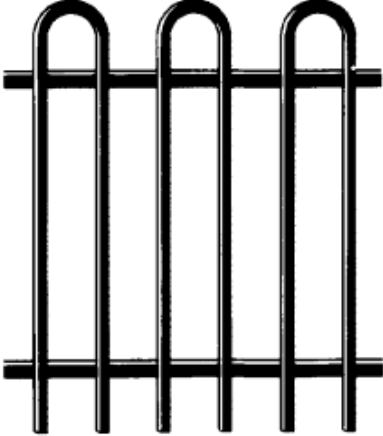
 <p style="text-align: center;"><b>Royal Eagle</b></p>	Description	Price each
	8' section x 36" high	182.54
	8' section x 48" high	216.82
	8' section x 60" high	251.11
	8' section x 72" high	285.40
	3½' gate x 48" high	200.80
	5' gate x 48" high	234.71
	3½' gate x 60" high	218.31
	5' gate x 60" high	257.24
	3½' gate x 72" high	235.82
5' gate x 72" high	279.78	

**Residential Three Rail system** – Silver Eagle, American Eagle

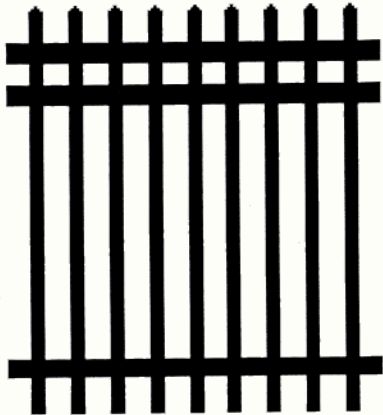
 <p style="text-align: center;"><b>American Eagle</b></p>	Description	Price each
	8' section x 36" high	213.36
	8' section x 48" high	247.65
	8' section x 60" high	281.94
	8' section x 72" high	316.23
	3½' gate x 48" high	213.35
	5' gate x 48" high	252.33
	3½' gate x 60" high	230.86
	5' gate x 60" high	274.86
	3½' gate x 72" high	248.36
5' gate x 72" high	297.40	

Posts - standard	Description	Price each
	2" square x 7' with pyramid cap	39.17
	2" square x 8' with pyramid cap	44.27
	2" square x 9' with pyramid cap	49.38

**Iron Eagle 2000 series** – 5/8" x 5/8" pickets, 1" x1" rails. Picket top available in Arrow, maple Leaf or Fleur de Lis – (includes universal brackets)

**Residential Two Rail system** – 2000, 2020, 2030, 2040 (Rings and Finials extra)

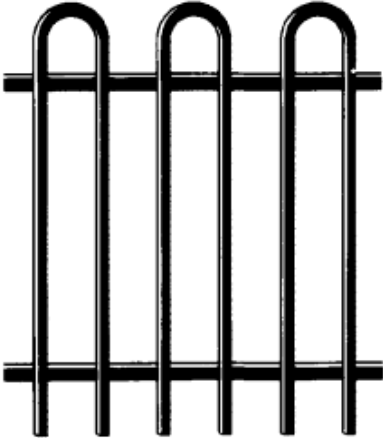



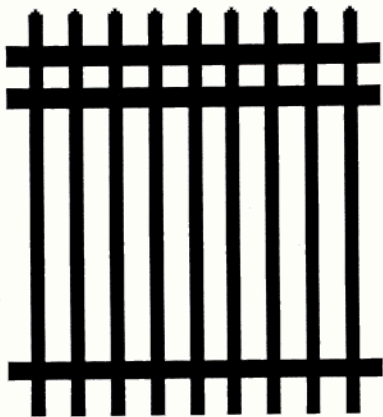

 <p style="text-align: center;"><b>2020</b></p>	Description	Price each
	8' section x 36" high	198.69
	8' section x 48" high	237.88
	8' section x 60" high	277.07
	8' section x 72" high	316.26
	3½' gate x 48" high	215.10
	5' gate x 48" high	252.30
	3½' gate x 60" high	234.64
	5' gate x 60" high	277.70
	3½' gate x 72" high	254.19
5' gate x 72" high	303.10	

**Residential Three Rail system** – 2100, 2110, 2140, 2150 (Rings and finials extra)

 <p style="text-align: center;"><b>2100</b></p>	Description	Price each
	8' section x 36" high	230.06
	8' section x 48" high	269.25
	8' section x 60" high	308.43
	8' section x 72" high	347.62
	3½' gate x 48" high	236.85
	5' gate x 48" high	279.13
	3½' gate x 60" high	256.39
	5' gate x 60" high	304.52
	3½' gate x 72" high	275.94
5' gate x 72" high	329.93	

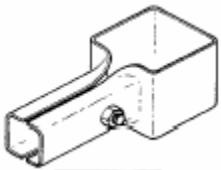
Posts - standard	Description	Price each
	2" square x 7' with pyramid cap	39.17
	2" square x 8' with pyramid cap	44.27
	2" square x 9' with pyramid cap	49.38

## Iron Eagle Tradition and 2000 Series Residential Fittings

Description	Price	Description	Price
2" x 2" End Swivel Bracket 	7.13	2" x 2" Line Swivel Bracket 	10.69
2" x 2" Universal Bracket 	2.87	2" x 2" Line Bracket 	4.06
2" x 2" End Bracket 	3.03	1" x 1" Aluminum Wall Bracket 	2.97
1" x 1" Aluminum Wall Bracket c/w 20 Degree Angle 	3.12	2" x 2" Brace Band 	3.02
		2" x 2" Tension Band 	2.97

**Colours:**

(HB) High-Gloss Black	(WH) White	(SB) Semi-Gloss Black
(GR) Green	(BR) Brown	(FG) Forest Green
(SP) Special		

**Iron Eagle Tradition and 2000 Series Residential Fittings – cont'd.**

Description	Price	Description	Price
4 Sided Spire Post Cap 2" x 2" Aluminum 	8.92	4 Sided Acorn Post Cap 2" x 2" Aluminum 	9.50
Pyramid Post Cap 2" x 2" Aluminum 	3.42	Ball Post Cap 	8.17

**Colours:**

(HB) High-Gloss Black	(WH) White	(SB) Semi-Gloss Black
(GR) Green	(BR) Brown	(FG) Forest Green
(SP) Special		

## Iron Eagle Tradition and 2000 Series Residential Gate Fittings

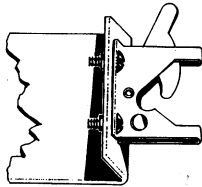
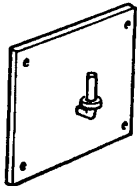
<p>Self Closure (set)                  1 – 2" x 2" Post Collar                  2 – 1" x 1" Gate Collar</p> 	24.75	<p>Post Collar - 2" - c/w bolt</p> <p>Frame Collar - 1"</p> <p>Latch Catch - 2"</p> <p>Finger Latch - 1"</p> <p>½" x 24" Cane bolt</p>	<p>9.90</p> <p>5.33</p> <p>11.99</p> <p>6.16</p> <p>28.33</p>
<p>Wall Latch                  c/w Bracket</p> 	8.37	<p>Wall Plate                  c/w ½" Hinge Bolt                  4" x 4" Plate</p> 	15.49

**Colours:**

- |                       |            |                       |
|-----------------------|------------|-----------------------|
| (HB) High-Gloss Black | (WH) White | (SB) Semi-Gloss Black |
| (GR) Green            | (BR) Brown | (FG) Forest Green     |
| (SP) Special          |            |                       |

**Iron Eagle II** – ¾" x 1½" pickets, 1½" x 2½" rails. Picket top available in Arrow, Maple Leaf or Fleur de Lis (**brackets are extra**)

**Industrial Two Rail system** – Elegant Eagle II, Imperial Eagle II, Majestic Eagle II, Royal Eagle II





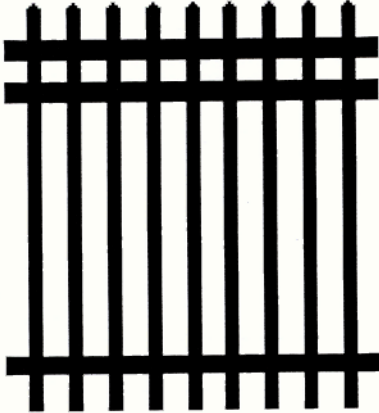

 <p style="text-align: center;"><b>Royal Eagle II</b></p>	Description	Price each
	8' section x 48" high	417.66
	8' section x 60" high	484.94
	8' section x 72" high	550.25
	3½' gate x 48" high	448.32
	5' gate x 48" high	541.82
	3½' gate x 60" high	494.78
	5' gate x 60" high	604.50
	3½' gate x 72" high	540.26
5' gate x 72" high	665.74	

**Industrial Three Rail system** – Canadian Eagle II, Royal Elegant II, Silver Eagle II, Golden Eagle II, Majestic Elegant II

 <p style="text-align: center;"><b>Golden Eagle II</b></p>	Description	Price each
	8' section x 48" high	480.60
	8' section x 60" high	547.88
	8' section x 72" high	613.18
	3½' gate x 48" high	527.46
	5' gate x 48" high	632.53
	3½' gate x 60" high	573.92
	5' gate x 60" high	695.22
	3½' gate x 72" high	619.41
5' gate x 72" high	756.45	

Posts – 14 ga.	Description	Price each
	3" square x 7' with pyramid cap	84.88
	3" square x 8' with pyramid cap	96.13
	3" square x 9' with pyramid cap	107.38

## Iron Eagle II Industrial Fittings

Description	Price	Description	Price
3" x 3" Line Bracket 	11.14	Universal Swivel Bracket 	8.91
Universal Bracket End-Line – c/w nut and bolt 		Corner Elevations 3" x 3" Corner Elevations 4" x 4" Corner Elevations 6" x 6"	7.48 9.90 14.36
3" x 3" Aluminum Pyramid Cap 	6.17	3" x 3" Brace Band 4" x 4" Brace band 6" x 6" Brace Band 	3.51 9.67 16.58
		3" x 3" Tension Band 4" x 4" Tension Band 6" x 6" Tension Band 	3.40 8.59 16.58

**Colours:**

(HB) High-Gloss Black      (WH) White      (SB) Semi-Gloss Black  
 (GR) Green      (BR) Brown      (FG) Forest Green  
 (SP) Special