



McGowan Fence & Supply Limited

811 Progress Avenue
Scarborough, Ontario M1H 2X4
Tel (416)431-5556 Fax (416)431-2595

2017 CATALOGUE **All Products and Price List**

QUALITY
and
Service

Since 1948

TERMS AND CONDITIONS

ALL PRICES, EXCEPT THOSE LISTED AS NET, ARE SUBJECT TO YOUR DEALER DISCOUNT. (TO CONFIRM DISCOUNT LEVEL, PLEASE PHONE)

ALL PRICES ARE C.O.D. UNLESS PRIOR CREDIT ARRANGEMENTS HAVE BEEN ESTABLISHED. PAYMENT BY CASH, APPROVED CHEQUE, DEBIT CARD, VISA, OR MASTER CARD.

ALL PRICES ARE F.O.B. OUR YARD, 811 PROGRESS AVE. SCARBOROUGH, ONTARIO M1H 2X4. DELIVERIES TO BE ARRANGED.

THE H.S.T. SALES TAX (IF APPLICABLE) IS EXTRA TO ALL CATALOGUE PRICES.

PRICES AND SPECIFICATIONS SUBJECT TO CHANGE WITHOUT NOTICE.

Illustrations reprinted with permission of Metro Fence & Fittings Ltd.

Table of Contents – Complete Catalogue

Residential Section (R)

Residential Fence Kits - 10' Centers	R-1
Residential Fence Kits - 8' Centers	R-2
End Post Kits	R-3
Corner Post Kits	R-3
Gates	R-3
Residential Double Gates	R-4
Gate Frames	R-4
Residential Galvalume Tubing	R-4
Coloured Residential Tubing - Posts and Rail	R-5
Coloured Fittings	R-5
Coloured Gates	R-6
Coloured Gate Frames	R-6
Coloured Gate Hardware	R-6
Chain Link Fabrics per Foot	R-7
Galvanized	R-7
Vinyl Coated	R-7
Chain Link Fabrics per Roll	R-8
Galvanized	R-8
Vinyl Coated	R-8
Residential Chain Link Fence Fittings	R-9
Tension Bands	R-9
Brace Bands	R-9
Rail Ends	R-9
Post Caps	R-9
Tension Bars	R-9
Line Post Caps	R-9
Tie Wires	R-10
Bolts and Nuts	R-10
Bottom Wire	R-10
Bottom Wire Clips	R-10
Galvanized Gate Clips	R-10
Residential Chain Link Gate Hardware	R-11
Post Collars	R-11
Spring Closures	R-11
Frame Collars	R-11
Hinge Bolts	R-11
Finger Latches	R-11
Latch Catches	R-11
Cane Bolts	R-11

Industrial Section (I)

Industrial Fence Kits - Spec #2	I-1
End Posts	I-1
Corner Posts	I-1
Industrial Fence Kits - Spec #3	I-2
End Posts	I-2
Corner Posts	I-2
Chain Link Fabrics per Foot	I-3
Galvanized	I-3
Vinyl Coated	I-3
Chain Link Fabrics per Roll	I-4
Galvanized	I-4
Vinyl Coated	I-4
Galvanized Pipe	I-5
Schedule 40	I-5
Light Wall	I-5
Industrial Chain Link Swing Gates	I-6
Industrial Chain Link Fence Fittings	I-7
Tension Bands	I-7
Brace Bands	I-7
Rail Ends	I-7
Post Caps	I-7
Line Post Caps	I-7
Tension Bars	I-8
Gate Caps	I-8
Sleeves	I-8
Boulevard Clamps	I-8
Tie Wires	I-9
Bolts and Nuts	I-9
Bottom Wire	I-9
Bottom Wire Clips	I-9
Eye Bolts and Brackets	I-9
Turnbuckles	I-9
Sleeve Anchors	I-9
Overhang Barbed Wire Arms	I-10
Vertical Barbed Wire Arms	I-10
Corner Barbed Wire Arms	I-10
Industrial Chain Link Gate Hardware	I-11
Post Collars	I-11
Spring Closures	I-11
Frame Collars	I-11
Hinge Bolts	I-11
Latch Catches	I-12
Drop Latches	I-12
Wall Latch	I-12
Gate Chain Hold Opens	I-12
Cane Bolts	I-12
Centre Rests	I-12
Galvanized Chain	I-12

Misc. Section (M)

Welded Wire Fabric.....M-1
Barbed WireM-1
StaplesM-1
Pre-Galvanized Flex Beam Guard Rail.....M-1
Farm Fence.....M-2
Farm Gates.....M-2
Merchant WireM-3
Quik RokM-3
Painted Steel T-Posts and ClipsM-3
Vexar Plastic Fence.....M-4
Snow Fence Ties.....M-4
Dog Kennels.....M-5

Ornamental Section (O)

Iron Eagle Tradition - Residential O-1
Residential Two Rail system O-1
Residential Three Rail system O-1
Posts..... O-1
Iron Eagle 2000 Series - Residential..... O-2
Residential Two Rail system O-2
Residential Three Rail system O-2
Posts..... O-2
Iron Eagle Residential Fittings O-3
Iron Eagle II - Industrial O-6
Industrial Two Rail system O-6
Industrial Three Rail system O-6
Posts..... O-6
Iron Eagle Industrial Fittings O-7

Residential Fence Kits – 10 Foot Centers - Per Foot Price

All per foot prices of our fence kits include the following:

Line posts spaced every 10 ft. with linepost caps, top rail in 10 ft. sections (swedged), chain link fabric, bottom wire and tie wires.

Height and Mesh Size	Galvanized Frame		Coloured Frame
	Galv. Fabric	Vinyl Fabric	Vinyl Fabric
2" Mesh - 9ga. 36" High 42" High 48" High 60" High 72" High		4.36 4.69 5.02 5.82 6.97	5.17 5.50 5.83 6.67 7.85
1½" Mesh - 11ga. 36" High 42" High 48" High 60" High 72" High		On Request On Request 5.43 6.33 7.58	On Request On Request 6.24 7.18 8.46
1½" Mesh - 9ga. 36" High 42" High 48" High 60" High 72" High		On Request On Request 6.12 7.19 8.62	On Request On Request 6.93 8.04 9.49
2¼" Mesh - 11ga. 48" High 60" High 72" High	5.16 5.99 7.17		

Vinyl frame and fabric available in green, white, black or brown.

Residential Fence Kits – 8 Foot Centers - Per Foot Price

All per foot prices of our fence kits include the following:

Line posts spaced every 8 ft. with linepost caps, top rail in 10 ft. sections (swedged), chain link fabric, bottom wire and tie wires.

Note: Residential fencing with 8 ft. centers may be required for pool enclosures in your area. Check your municipal bylaws for the exact legal requirements.

Height and Mesh Size	Galvanized Frame		Coloured Frame
	Galv. Fabric	Vinyl Fabric	Vinyl Fabric
2" Mesh - 9ga. 36" High 42" High 48" High 60" High 72" High		4.62 4.96 5.29 6.11 7.39	5.52 5.85 6.18 7.06 8.37
1½" Mesh - 11ga. 36" High 42" High 48" High 60" High 72" High		On Request On Request 5.69 6.62 8.00	On Request On Request 6.59 7.57 8.98
1½" Mesh - 9ga. 36" High 42" High 48" High 60" High 72" High		On Request On Request 6.39 7.49 9.04	On Request On Request 7.28 8.44 10.02
2¼" Mesh - 11ga. 48" High 60" High 72" High	5.42 6.28 7.59		

Vinyl frame and fabric available in green, white, black or brown.

Residential Fence Kits - End or Corner Posts; Gates

Residential End Post Kits

All end post kits include 1 post, 1 $\frac{1}{8}$ " O.D. (2 $\frac{3}{8}$ " O.D. for 6 ft. fence). Length to suit fence height, complete with post cap, rail end and brace band, tension bands, tension bar and bolts and nuts.

Fence Height	Galvanized	Coloured
36", 42" or 48" High Fence	20.05	27.54
60" High Fence	23.26	32.00
72" High Fence	30.36	40.41

Residential Corner Post Kits

All corner posts include 1 post, as above, but 2 complete sets of fittings.

Fence Height	Galvanized	Coloured
36", 42" or 48" High Fence	27.72	39.39
60" High Fence	32.47	46.17
72" High Fence	41.18	56.87

Residential Gates

Unit prices are for 2 pc. gate frame 1 $\frac{1}{4}$ " O.D. tubing complete with chain link infill and all necessary latching and hinging hardware for 1 $\frac{7}{8}$ " O.D. post.

1 $\frac{7}{8}$ " spring closures are extra @ \$24.81 ea.

Upgrade to 2 $\frac{3}{8}$ " O.D. hardware extra @ \$3.41 per set (includes 2 $\frac{3}{8}$ " post collars and latch catch)

Gate Height	3 Ft. Wide	3 $\frac{1}{2}$ Ft. Wide	4 Ft. Wide	5 Ft. Wide	6 Ft. Wide
36" High	110.03	110.03	111.32		
42" High	110.03	110.03	111.32		
48" High	110.03	110.03	111.32	128.52	135.35
60" High	115.11	115.11	117.01	130.30	
72" High	119.50	119.50	123.06		

Residential Double Gates

2 pc. Frame 1¼" O.D. Tubing, complete with chain link infill and all necessary latching and hinging hardware.

	Width				
	6'	7'	8'	10'	12'
Height	1- 7/8" Fittings			2-3/8" Fittings	
36"	241.74	241.74	244.32		
42"	241.74	241.74	244.32		
48"	241.74	241.74	244.32	281.38	295.05
60"	251.90	251.90	255.70	284.96	
72"	260.68	260.68	267.81		

Residential Gate Frames

Unit prices are for 2 pc. gate frame 1¼" O.D. galvalume tubing only. (No infill or hardware included.)

Gate Height	3 Ft. Wide	3½ Ft. Wide	4 Ft. Wide	5 Ft. Wide
36" High	25.87	25.87	26.03	
42" High	25.87	25.87	26.03	
48" High	25.87	25.87	26.03	32.02
60" High	28.46	28.46	29.12	34.60
72" High	30.25	30.25	32.60	

Residential Galvalume Tubing - Posts, Top Rail and Gate Extensions - Price Each

Size	Description	Gauge	Length	#/Bdle	Loose	Bundle Lot
1-¼"	Toprail	17 ga.	10'4"	91	12.55	11.41
1-½"	Line Post	17 ga.	6'6"	61	9.42	8.56
1-½"	Line Post	17 ga.	7'6"	61	10.88	9.89
1-7/8"	Main Post	17 ga.	6'6"	61	12.07	10.97
1-7/8"	Main Post	17 ga.	7'6"	61	13.92	12.65
1-7/8"	Main Post	17 ga.	8'6"	61	15.77	14.33
2-3/8"	Main Post	17 ga.	8'6"	37	19.77	17.97
1-¼"	Gate Extensions	17 ga.	42"	-	5.73	-
1-¼"	Gate Extensions	17 ga.	66"	-	9.23	8.78

Coloured Residential Tubing – Posts, Top Rail and Gate Extensions

Available in Green, White, Black, Brown

Size	Description	Gauge	Length	Price Each
1-¼"	Toprail	17 ga.	10'3"	17.58
1-½"	Line Post	17 ga.	6'6"	12.62
1-½"	Line Post	17 ga.	7'6"	14.56
1-⅞"	Main Post	17 ga.	6'6"	15.25
1-⅞"	Main Post	17 ga.	7'6"	17.60
1-⅞"	Main Post	17 ga.	8'6"	19.94
2-⅜"	Main Post	17 ga.	8'6"	23.93
1-¼"	Gate Extensions - Double Swedged	17 ga.	66"	12.38

Coloured Residential Fittings

Description	Size	Price Each
Line Post Caps	1-½"	1.78
	1-⅞"	2.05
Main Post Caps	1-⅞"	1.83
	2-⅜"	2.21
Tension Bands w/bolt and nut	1-⅞"	1.04
	2-⅜"	1.19
Brace Bands w/bolt and nut	1-⅞"	1.04
	2-⅜"	1.19
Rail Ends	1-¼"	1.56
Tension Bars	36"	4.00
	42"	4.67
	48"	5.34
	60"	6.67
	72"	8.01
Tie Wires	11 ga.	.10
	9 ga.	.15
Bottom Wire	9 ga.	.18/ft.

Coloured Residential Gates – Includes chain link infill and fittings for 1-7/8" posts for 48" and 60" high gates and 2-3/8" fittings for 72" high gates

Size	Price Each
3-1/2' x 48"	127.27
3-1/2' x 60"	136.72
3-1/2' x 72"	146.19

Coloured Residential Gate Frames – (No infill or hardware included.)

Size	Price Each
4' x 48" high	35.98
4' x 60" high	39.85
4' x 72" high	43.72

Coloured Residential Gate Hardware

Description	Price Each
Post collars – 1-7/8"	6.51
Post collars – 2-3/8"	7.58
Frame collars – 1-1/4"	4.27
Finger latches – 1-1/4"	15.06
Latch catches – 1-1/4"	8.93
Latch catches – 1-7/8"	7.49
Latch catches – 2-3/8"	9.54
Wall latch w/mounting plate and sleeve anchors	14.85
Flipper latch only	7.97
Spring closures – 1-7/8" x 1-1/4"	29.48
Spring closures – 2-3/8" x 1-1/4"	35.56
Cane Bolt – 1/2" x 24" w/frame collars	21.07
Gate clips – 1-1/4"	.74

Chain Link Fabrics – per foot price, weights per 100 feet

Galvanized

Fence Height	2"- 6ga.	Wgt.	2"- 9ga.	Wgt.	2 ¼"- 11ga.	Wgt.	1½"- 9ga.	Wgt.
3'			3.06	183				
3-½'			3.57	214				
4'	9.07	474	4.08	244	3.06	150	6.90	364
5'	11.34	592	5.10	305	3.83	186	8.62	454
6'	13.60	710	6.12	366	4.59	226	10.35	544
7'	15.87	828	7.14	427			12.07	636
8'	18.14	946	8.16	488			13.80	726
10'	22.67	1182	10.20	610			17.25	908
12'	27.21	1418	12.24	732			20.70	1090

Vinyl Coated – green, white, black, brown

Fence Height	2"- 6ga.	Wgt.	2"- 9ga.	Wgt.	2"- 11ga.	Wgt.	1½"- 9ga.	Wgt.	1½"- 11ga.	Wgt.
3'			2.18	106	Not	68				100
3-½'			2.55	126	A	86				116
4'	6.27	286	2.91	144	Stock	98	4.12	210	3.36	132
5'	7.84	384	3.64	176	Item	124	5.15	264	4.20	166
6'	9.41	440	4.37	214		142	6.18	320	5.04	200
7'	10.97	536	5.10	252			7.21	374		
8'	12.54	592	5.82	314			8.24	420	1¾"- 9ga.	
10'	15.68	782	7.28	392			10.30	528	9.97	464
12'	18.81	938	8.74	470			12.36	640	11.97	560

Chain Link Fabrics – prices per 50 foot roll

Aluminum Fabric
 - prices available on request-

Galvanized

Fence Height	2"- 6ga.	2"- 9ga.	2 ¼"- 11ga.	1-½"- 9ga.
3'		139.14		
3-½'		162.33		
4'	412.24	185.52	139.11	313.60
5'	515.30	231.90	173.88	392.00
6'	618.36	278.28	208.66	474.40
7'	721.42	324.65		548.80
8'	824.48	371.03		627.20
10'	1,030.60	463.79		784.00
12'	1,236.72	556.55		940.80

Vinyl Coated – green, white, black, brown

Fence Height	2"- 6ga.	2"- 9ga.	2"- 11ga.	1-½"- 9ga.	1-½"- 11ga.
3'		99.26			
3-½'		115.81			
4'	285.06	132.35		187.33	152.71
5'	356.33	165.44		234.16	190.89
6'	427.59	198.53		280.99	229.07
7'	498.86	231.61			
8'	570.12	264.70		374.65	1 ¾" - 9 ga.
10'	712.66	330.88		468.32	453.05
12'	855.19	397.05		561.98	543.65

Wire Selvage



Knuckle Top

Residential Chain Link Fence Fittings

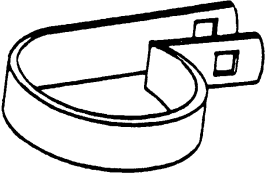
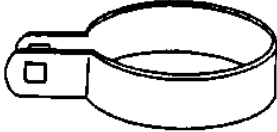
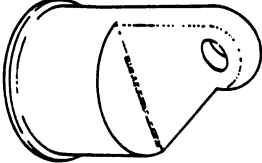
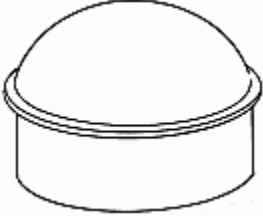
Tension Bands (with bolt and nut)	Size	Price each	Brace Bands (with bolt and nut)	Size	Price each
		1 ⁷ / ₈ "		.61	
	2 ³ / ₈ "	.71		2 ³ / ₈ "	.71
Rail Ends	Size	Price each	Post Caps	Size	Price each
	1 ¹ / ₄ "	1.01		1 ⁷ / ₈ "	1.40
				2 ³ / ₈ "	1.58

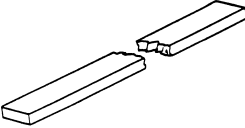
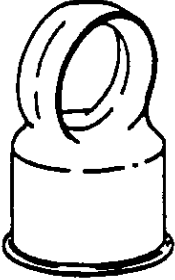
Tension Bars	Size	Price each	Line Post Caps	Size	Price each
		1/2" Steel			1-1/2"
	36"	2.92		1-7/8" x 1-5/16"	1.57
	42"	3.40			
	48"	3.89			
	60"	4.86			
	72"	5.84			

Residential Chain Link Fence Fittings (cont'd)

Description	Size	Quantity	Price each
Tie Wires	11ga. x 6 ½" aluminum	Each	.10
		Per 100	9.62
	11ga. x 6 ½" vinyl	Each	.10
		Per 100	9.62
Bolts and Nuts	5/16" x 1 ¼"	Each	.20
		Per 100	17.82
Bottom Wire	9ga. galvanized	Per foot	.15
		Per 50lb. coil	129.66
	9ga. vinyl	Per foot	.18
		Per 50lb. coil	174.36
Bottom Wire Clips		Per box of 1000	70.56
Galvanized Gate Clips		Each	.33

Residential Chain Link Gate Hardware

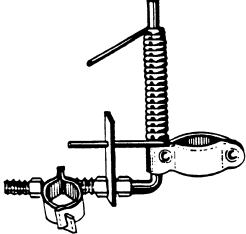
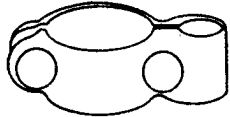
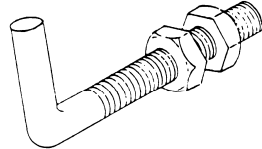
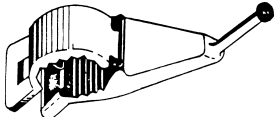
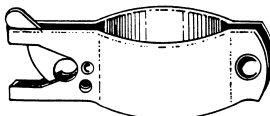
Residential Post Collars	Size	Price each
	Pressed Steel	
	1 $\frac{7}{8}$ " x 1 $\frac{1}{2}$ " w/ bolt	3.63
	2 $\frac{3}{8}$ " x 1 $\frac{1}{2}$ " w/ bolt	4.29
Residential Spring Closures 	1 $\frac{7}{8}$ "	24.81
	2 $\frac{3}{8}$ "	31.48
Residential Frame Collars 	1 $\frac{1}{4}$ "	1.90
Residential Hinge Bolts 	1 $\frac{1}{2}$ " x 3" w/nuts	2.10
	1 $\frac{1}{2}$ " x 3" lag	2.32
	1 $\frac{1}{2}$ " x 7" w/nuts	5.25
Residential Finger Latches 	1 $\frac{1}{4}$ "	13.82
Residential Latch Catches 	1 $\frac{1}{4}$ "	7.70
	1 $\frac{7}{8}$ "	6.17
	2 $\frac{3}{8}$ "	8.25
Wall Latch w/mounting plate	w/sleeve anchors	13.59
Flipper latch only		7.03
Residential Cane Bolts	1 $\frac{1}{2}$ " x 24" w/brackets	20.16

Industrial Fence Kits – Spec #2

Includes 2- $\frac{3}{8}$ " O.D. lineposts and caps or overhang barbarm (10' O.C.), 1- $\frac{11}{16}$ " O.D. top rail with sleeves, 2" x 9ga. galvanized chain link fabric (1.2 oz.), 9 ga. bottom wire and 9 ga. aluminum ties. For vertical barbarm add .11/ft.

Fence Height	.100 Wall		Schedule 40	
	FFH	+Barb	FFH	+Barb
48"	8.47		10.26	
60"	9.70		11.64	
72"	10.93	11.71	13.01	13.79
96"	13.38	14.16	15.76	16.55
120"	15.83	16.61	18.52	19.30

End Posts – includes 3- $\frac{1}{2}$ " O.D. post with cap, 1 tension bar, tension bands, brace band and rail end.

Fence Height	.125 Wall		Schedule 40	
	FFH	+Barb	FFH	+Barb
48"	57.24		87.11	
60"	64.92		98.77	
72"	71.79	82.21	109.62	124.01
96"	87.15	97.56	132.94	147.33
120"	103.31	113.73	157.07	171.46

Corner Posts – includes 3- $\frac{1}{2}$ " O.D. post with cap, 2 tension bar, tension bands, brace bands and rail ends.

Fence Height	.125 Wall		Schedule 40	
	FFH	+Barb	FFH	+Barb
48"	67.85		97.71	
60"	77.38		111.23	
72"	85.31	100.32	123.13	142.13
96"	104.38	119.39	150.17	169.17
120"	125.08	140.09	178.83	197.82

Extra Terminal Post Braces @ 27.08 for .100 wall or 34.80 or Schedule 40.

Industrial Fence Kits – Spec #3

Includes 1-7/8" O.D. lineposts and caps or overhang barbarm (10' O.C.), 1-5/16" O.D. top rail with sleeves, 2" x 9ga. galvanized chain link fabric (1.2 oz.), 9 ga. bottom wire and 9 ga. aluminum ties.

Fence Height	.100 Wall		Schedule 40	
	FFH	+Barb	FFH	+Barb
48"	7.51		8.68	
60"	8.68		9.94	
72"	9.84	10.45	11.20	11.82
96"	12.17	12.78	13.73	14.34
120"	14.49	15.11	16.25	16.86

End Posts – includes 2-3/8" O.D. post with cap, 1 tension bar, tension bands, brace band and rail end.

Fence Height	.100 Wall		Schedule 40	
	FFH	+Barb	FFH	+Barb
48"	34.29		46.12	
60"	39.14		52.55	
72"	43.34	48.46	58.32	65.02
96"	53.05	58.17	71.18	77.89
120"	63.42	68.54	84.71	91.41

Corner Posts – includes 2-3/8" O.D. post with cap, 2 tension bar, tension bands, brace bands and rail ends.

Fence Height	.100 Wall		Schedule 40	
	FFH	+Barb	FFH	+Barb
48"	43.43		55.26	
60"	50.00		63.41	
72"	55.25	62.35	70.23	78.92
96"	68.38	75.49	86.52	95.21
120"	82.84	89.95	104.13	112.82

Extra Terminal Post Braces @ 26.25 for .100 wall or 33.93 for Schedule 40.

Chain Link Fabrics – per foot price, weights per 100 feet

Galvanized

Fence Height	2"- 6ga.	Wgt.	2"- 9ga.	Wgt.	2¼" – 11ga.	Wgt.	1½"- 9ga.	Wgt.
3'			3.06	183				
3-½'			3.57	214				
4'	9.07	474	4.08	244	3.06	150	6.90	364
5'	11.34	592	5.10	305	3.83	186	8.62	454
6'	13.60	710	6.12	366	4.59	226	10.35	544
7'	15.87	828	7.14	427			12.07	636
8'	18.14	946	8.16	488			13.80	726
10'	22.67	1182	10.20	610			17.25	908
12'	27.21	1418	12.24	732			20.70	1090

Vinyl Coated – green, white, black, brown

Fence Height	2"- 6ga.	Wgt.	2"- 9ga.	Wgt.	2"- 11ga.	Wgt.	1½"- 9ga.	Wgt.	1½"- 11ga.	Wgt.
3'			2.18	106	Not	68				100
3-½'			2.55	126	A	86				116
4'	6.27	286	2.91	144	Stock	98	4.12	210	3.36	132
5'	7.84	384	3.64	176	Item	124	5.15	264	4.20	166
6'	9.41	440	4.37	214		142	6.18	320	5.04	200
7'	10.97	536	5.10	252			7.21	374		
8'	12.54	592	5.82	314			8.24	420	1¾"- 9ga.	
10'	15.68	782	7.28	392			10.30	528	9.97	464
12'	18.81	938	8.74	470			12.36	640	11.97	560

Chain Link Fabrics – prices per 50 foot roll

Aluminum Fabric
 - prices available on request-

Galvanized

Fence Height	2"- 6ga.	2"- 9ga.	2¼" – 11ga.	1-½"- 9ga.
3'		139.14		
3-½'		162.33		
4'	412.24	185.52	139.11	313.60
5'	515.30	231.90	173.88	392.00
6'	618.36	278.28	208.66	474.40
7'	721.42	324.65		548.80
8'	824.48	371.03		627.20
10'	1030.60	463.79		784.00
12'	1236.72	556.55		940.80

Vinyl Coated – green, white, black, brown

Fence Height	2"- 6ga.	2"- 9ga.	2"- 11ga.	1-½"- 9ga.	1-½"- 11ga.
3'		99.26			
3-½'		115.81			
4'	285.06	132.35		187.33	152.71
5'	356.33	165.44		234.16	190.89
6'	427.59	198.53		280.99	229.07
7'	498.86	231.61			
8'	570.12	264.70		374.65	1 ¾" - 9 ga.
10'	712.66	330.88		468.32	453.05
12'	855.19	397.05		561.98	543.65

Wire Selvage



Knuckle Top



Barbed Top

Galvanized Pipe – plain ends

Schedule 40

O.D. Size	Wall Thickness	Weight per 100'	Price		
			Per Foot	Per 100'	Per 21'
1- ⁵ / ₁₆ "	.133	169 lbs.	2.40	218.48	45.88
1- ¹¹ / ₁₆ "	.140	227 lbs.	3.23	293.47	61.63
1- ⁷ / ₈ "	.145	272 lbs.	3.87	351.64	73.84
2- ³ / ₈ "	.154	365 lbs.	5.19	471.87	99.09
2- ⁷ / ₈ "	.203	579 lbs.	8.23	748.53	157.19
3- ¹ / ₂ "	.216	758 lbs.	10.78	979.94	205.79
4- ¹ / ₂ "	.237	1079 lbs.	15.34	1,394.93	292.94
6- ⁵ / ₈ "	.280	1897 lbs.	26.98	2,452.44	515.01

Light Wall

O.D. Size	Wall Thickness	Weight per 100'	Price		
			Per Foot	Per 100'	Per 21'
1- ⁵ / ₁₆ "	.100	130 lbs.	1.85	168.06	35.29
1- ¹¹ / ₁₆ "	.100	167 lbs.	2.37	215.90	45.34
1- ⁷ / ₈ "	.100	192 lbs.	2.73	248.22	52.13
2- ³ / ₈ "	.100	243 lbs.	3.46	314.15	65.97
2- ⁷ / ₈ "	.125	367 lbs.	5.22	474.46	99.64
3- ¹ / ₂ "	.125	450 lbs.	6.40	581.76	122.71

Industrial Chain Link Swing Gates - .100 Wall Hot Dip Galvanized Frame

Includes 3-½" O.D. hardware (2 sets of gate hinges), 2" x 9ga. Galvanized fill and 1 11/16" O.D. x .100 wall hot dip galvanized frame, F.F.H. or B.W.O.

	Width					
Height	4'	5'	6'	7'	8'	9'
3'	470.96	495.36	569.83	581.36	594.39	606.71
4'	470.96	495.36	569.83	581.36	594.39	606.71
5'	470.96	495.36	569.83	581.36	594.39	606.71
6'	495.36	507.69	581.36	594.39	606.66	619.02
7'	508.02	526.54	594.39	606.66	619.04	633.80
8'	526.54	533.23	606.66	619.04	835.13	832.25
9'	533.23	545.78	619.04	630.93	873.78	888.73
10'	545.78	558.38	630.93	642.77	941.78	968.11
11'	558.38	575.71	643.11	663.15	955.29	996.58
12'	575.69	583.52	663.15	787.04	994.45	1,038.76
	Width					
Height	10'	11'	12'	13'	14'	15'
3'	619.04	642.50	665.96	754.36	842.76	984.28
4'	619.04	642.50	665.96	754.36	842.76	984.28
5'	619.04	642.50	665.96	754.36	842.76	984.28
6'	631.37	697.10	762.84	873.56	984.28	1,022.15
7'	648.56	717.80	787.04	904.60	1,022.15	1,059.56
8'	829.37	925.68	1,021.98	1,119.77	1,217.57	1,259.31
9'	903.68	977.01	1,050.33	1,154.84	1,259.34	1,307.78
10'	994.45	1,025.50	1,056.55	1,182.17	1,307.78	1,352.90
11'	1,037.88	1,083.75	1,129.62	1,241.26	1,352.90	1,411.51
12'	1,083.08	1,129.38	1,175.69	1,293.60	1,411.51	1,457.16

Upgrade to 4 ½" gate hinge set (2 sets of gate hinges) – 35.40 Extra 4 ½" gate hinge set – 38.02
 Upgrade to 4 ½" latch catch – 15.96 Extra 3 ½" gate hinge set – 28.31

Note: gate hinge set includes 1 post collar, 1 frame collar and 1 hinge bolt

Prices for other size gates, schedule 40 pipe frame, aluminum pipe frame, overhead sliding gates, cantilever gates and all related hardware available on request.

Industrial Chain Link Fence Fittings

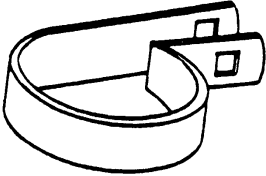
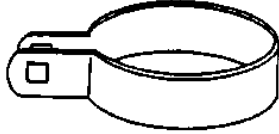
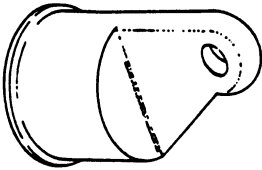
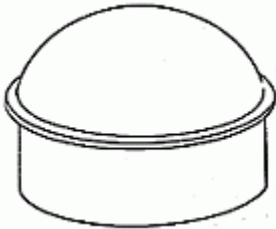
Tension Bands (with bolt and nut)	Size	Price each	Brace Bands (with bolt and nut)	Size	Price each
		1 ⁵ / ₁₆ "		.59	
1 ¹¹ / ₁₆ "		.61	1 ¹¹ / ₁₆ "	.62	
1 ⁷ / ₈ "		.61	1 ⁷ / ₈ "	.58	
2 ³ / ₈ "		.71	2 ³ / ₈ "	.71	
2 ⁷ / ₈ "		.78	2 ⁷ / ₈ "	.78	
3 ¹ / ₂ "		.85	3 ¹ / ₂ "	.85	
4 ¹ / ₂ "		1.69	4 ¹ / ₂ "	1.34	
6 ⁵ / ₈ "		3.73	6 ⁵ / ₈ "	3.73	
Rail End	Size	Price each	Post Cap	Size	Price each
	1 ¹ / ₄ "	1.01		1 ⁷ / ₈ "	1.40
	1 ⁵ / ₁₆ "	1.36		2 ³ / ₈ "	1.58
	1 ¹¹ / ₁₆ "	1.63		2 ⁷ / ₈ "	2.48
				3 ¹ / ₂ "	3.01
				4 ¹ / ₂ "	5.80
				6 ⁵ / ₈ "	22.93

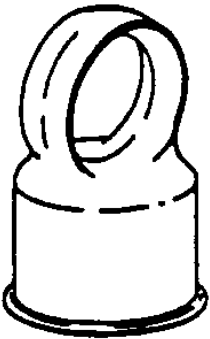
	Size	Price each
	1- ¹ / ₂ " x 1- ⁵ / ₁₆ "	1.20
	1- ⁵ / ₈ "	1.17
	1- ¹¹ / ₁₆ " x 1- ⁵ / ₁₆ "	1.59
	1- ¹¹ / ₁₆ " x 1- ¹¹ / ₁₆ "	1.65
	1- ⁷ / ₈ " x 1- ⁵ / ₁₆ "	1.57
	1- ⁷ / ₈ " x 1- ¹¹ / ₁₆ "	1.66
	2- ³ / ₈ " x 1- ¹¹ / ₁₆ "	2.14
	2- ⁷ / ₈ " x 1- ¹¹ / ₁₆ " STEEL	7.83
	2- ³ / ₈ " Top Wire Cap (MTO)	2.94

Industrial Chain Link Fence Fittings (cont'd)

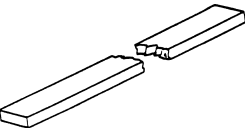
Tension Bars 	Size	Price each	Size	Price each
		¹ / ₂ " Steel		³ / ₄ " Steel
	36"	2.92	36"	3.16
	42"	3.40	42"	3.68
	48"	3.89	48"	4.21
	60"	4.86	60"	5.26
	72"	5.84	72"	6.31

Gate Caps 	Size	Price each
		1 ⁵ / ₁₆ "
	1 ¹¹ / ₁₆ "	1.72

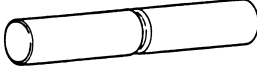
Sleeves 	Size	Price each
		1 ¹ / ₄ "
	1 ⁵ / ₁₆ "	2.00
	1 ¹¹ / ₁₆ "	2.24

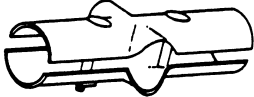
Boulevard Clamps 	Size	Price each
		1 ⁷ / ₈ " x 1 ⁵ / ₁₆ "
	2 ³ / ₈ " x 1 ¹¹ / ₁₆ "	3.94
	2 ⁷ / ₈ " x 1 ¹¹ / ₁₆ "	4.43

Industrial Chain Link Fence Fittings (cont'd)

Description	Size		Price each
Tie Wires	11ga. x 6½" aluminum or vinyl	Each	.10
		Per 100	9.62
	9ga. x 8¼" aluminum or vinyl	Each	.15
		Per 100	13.33
		Per box (price per 100)	12.63
	9ga. x 9½" aluminum or vinyl	Each	.15
		Per 100	12.94
	9ga. X 12" aluminum	Per 100	37.50
Bolts and Nuts	5/16" x 1¼"	Each	.20
		Per 100	17.82
Bottom Wire	9ga. galvanized	Per foot	.15
		Per 50lb. coil	129.66
	9ga. vinyl	Per foot	.18
		Per 50lb. coil	174.36
	6ga. galvanized	Per foot	.28
		Per 50lb. coil	138.13
	6ga. vinyl	Per foot	.47
		Per 50lb. coil	231.42
Bottom Wire Clips		Each	.10
		Per box of 1000	70.56
Misc. Hardware	Eye bolt w/nut		1.67
	Eye bolt bracket		3.91
Turnbuckles 	5/16" x 4"		5.31
	3/8" x 6"		8.28
Sleeve anchors	3/8" x 1 7/8"		.80
	1/2" x 2 1/4"		.84

Industrial Chain Link Fence Fittings (cont'd)

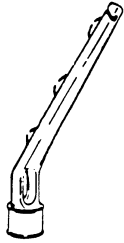
Overhang Barbed Wire Arms	Size	Price each
	1 $\frac{7}{8}$ " steel	4.67
	2 $\frac{3}{8}$ " steel *	4.93
	2 $\frac{3}{8}$ " aluminum	6.92
	2 $\frac{7}{8}$ " steel	8.20
	T-Post	5.61
	Double 2 $\frac{3}{8}$ " steel	14.56

Vertical Barbed Wire Arms	Size	Price each
	1 $\frac{7}{8}$ " steel *	5.51
	2 $\frac{3}{8}$ " steel *	6.11
	2 $\frac{3}{8}$ " aluminum	10.75

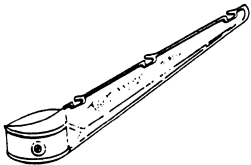
Corner Barbed Wire Arms	Size	Price each
	2 $\frac{7}{8}$ " aluminum	20.58
	3 $\frac{1}{2}$ " aluminum	23.42

Note: items with an * are non-stock

Industrial Chain Link Gate Hardware

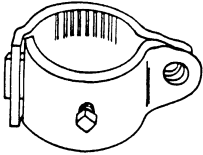
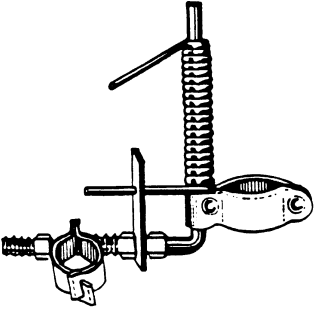
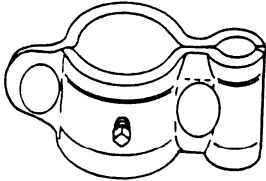
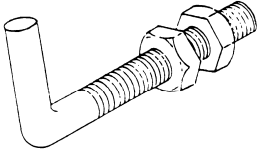
Industrial Post Collars with Set Screw 	Size	Price each
	Pressed Steel	
	2 ³ / ₈ " x 3/4" w/o bolt (light)	10.86
	2 ⁷ / ₈ " x 3/4" w/o bolt (light)	11.38
	3 ¹ / ₂ " x 3/4" w/o bolt (light)	11.04
	4 ¹ / ₂ " x 3/4" w/o bolt (heavy)	20.76
6 ⁵ / ₈ " x 1" w/o bolt (heavy)	82.81	
Industrial Spring Closures 		
	without post or frame collar	66.14
Industrial Frame Collars with Bolts, Nuts and Set Screw 	Industrial	
	1 ⁵ / ₁₆ " x 3/4" (light)	7.44
	1 ¹¹ / ₁₆ " x 3/4" (light)	9.61
	1 ⁷ / ₈ " x 3/4" (malleable)	36.90
	Wicket	
	1 ⁵ / ₁₆ " x 3/4"	15.66
1 ¹¹ / ₁₆ " x 3/4"	17.85	
Industrial Hinge Bolts with Nuts 		
	3/4" x 6" shoulder w/nuts	7.65
	3/4" x 8" w/nuts	10.05
	3/4" x 12" w/nuts and washers	7.81
	1" x 9" w/nuts	37.69

Industrial Chain Link Gate Hardware (cont'd)

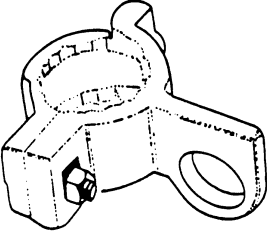
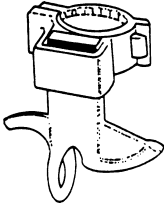
Industrial Latch Catch	Size	Price each
	1 ⁵ / ₁₆ "	30.78
	1 ¹¹ / ₁₆ "	27.57
	1 ⁷ / ₈ "	39.71
	2 ³ / ₈ "	40.50
	2 ⁷ / ₈ "	48.37
	3 ¹ / ₂ "	47.54
	4 ¹ / ₂ "	63.51
	6 ⁵ / ₈ "	75.28
Industrial Drop Latch		
	1 ⁵ / ₁₆ "	57.19
	1 ¹¹ / ₁₆ "	50.94
	1 ⁷ / ₈ "	77.03
Misc. Gate Hardware	Size	Price each
Wall latch		50.50
Gate chain hold opens w/center band	Galvanized	11.29
Cane bolts	¾" x 36" w/brackets	35.09
Centre rest	with pipe	51.28
	w/o pipe	41.93
Galvanized chain	1 ¹ / ₈ "	1.35/ft.
	3 ¹ / ₁₆ "	1.86/ft.
	5 ¹ / ₁₆ "	5.69/ft.

Standard Specifications for Industrial Chain Link Fence

Spec. #	Gauge	Mesh	Terminal Posts O.D.	Intermediate Posts O.D.	Top Rail O.D.	Full Fabric Height or including Barb Wire Overhang	Recommended Applications
1	6	2"	3½"	2¾"	1 ¹¹ / ₁₆ "	FFH or BWO	Heavy Industrial
2	9	2"	3½"	2¾"	1 ¹¹ / ₁₆ "	FFH or BWO	Industrial or Commercial
3	9	2"	2¾"	1¾"	1 ⁵ / ₁₆ "	FFH or BWO	Light Industrial or Commercial
4	9	1½"	3½"	2¾"	1 ¹¹ / ₁₆ "	FFH or BWO	Industrial or Commercial including Tennis Courts

Metric Conversion

Pipe Sizes	Fence Height	Wire Gauge	Common Metric Conversions Table	
			Convert	multiply by
1 ⁵ / ₁₆ " = 33.44mm	4' = 1.2m	6ga. = 5.0mm	metres to feet	3.2808
1 ¹¹ / ₁₆ " = 42.2mm	5' = 1.5m	9ga. = 3.5mm	mm to inches	0.0394
1 ⁷ / ₈ " = 48.3mm	6' = 1.8m	11ga. = 3.0mm	kg to pounds	2.2046
2 ³ / ₈ " = 60.3mm	7' = 2.1m		feet to metres	0.3048
2 ⁷ / ₈ " = 73.0mm	8' = 2.4m	Mesh Size	inches to mm	25.4003
3 ¹ / ₂ " = 88.9mm	10' = 3.0m	1½" = 38.1mm	pounds to kg	0.4536
4 ¹ / ₂ " = 114.3mm	12' = 3.6m	1¾" = 44.5mm		
6 ⁵ / ₈ " = 168.3mm		2" = 50.8mm		

Holes per Cubic Metre of Concrete

Depth	Diameter					
	6"	8"	10"	12"	16"	18"
36"	59.5	33.5	21.5	15.0	8.5	6.6
42"	51.1	28.7	18.3	12.7	7.2	5.7
48"	44.7	25.2	16.1	11.2	6.2	4.9
54"	39.8	22.4	14.3	9.9	5.6	4.4

1 cubic metre is approx. equal to 1.31 cubic yards

Welded Wire Fabric – standard galvanized – prices per 100' roll

Gauge	Mesh	Weight/100 sq. ft.	36"	48"	60"
16	1" X 1"	26lbs.	184.68	226.86	323.76
12	2" X 2"	35lbs.		303.24	379.62
10	2" X 2"	53lbs.		555.18	694.26

These are standard stock items. Prices on other sizes and gauges available on request.

Barbed Wire – 80 rod spools only (1320')

Type	Style number	Price per spool
4 point 5" x 15½ ga. Double Strand	Class 3, Hi-tensile	93.48

Staples – farm 1¼" galvanized, barbed

Description	Price each
Per 50 lb. box (approx. 2600 pcs.)	98.61

Pre-Galvanized Flex Beam Guard Rail

Description	Size	Price each
Guard rail – 12ga.	12'6"	145.00
Terminal section – 12ga.		75.00
Pressure treated Jackpine posts	8" x 8" x 7'4"	76.80
Pressure treated Jackpine blocks	8" x 8" x 15"	14.85

Farm Fence – Hi Tensile Class 3 Galvanized

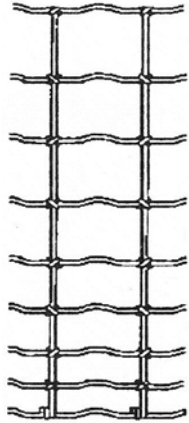
Style		Weight	Roll Size	Price	
8x42-12-12½	Fixed Knot	110 lbs.	20 rod (330 ft.)	245.10	
8x42-12-12½	Fixed Knot	220 lbs.	40 rod (660 ft.)	465.12	
9x49-12-12½	Fixed Knot	130 lbs.	20 rod (330 ft.)	279.30	
9x49-12-12½	Fixed Knot	260 lbs.	40 rod (660 ft.)	532.38	
The graphic image to the right shows a 9x49-12-12½ style farm fence. 9 is the number of horizontal line wires, 49 is the overall height in inches, 12 is the pull-out or distance, in inches, of the vertical stay wires and 12½ is the wire gauge. Notice that the horizontal line wires are spaced closer together at the bottom to prevent small animals from passing through.					
A rod is equivalent to 16.5 feet or 5.0292 metres. There are 320 rods in a mile.					

Farm Gates – with hold back chain, hinge bolts and washers

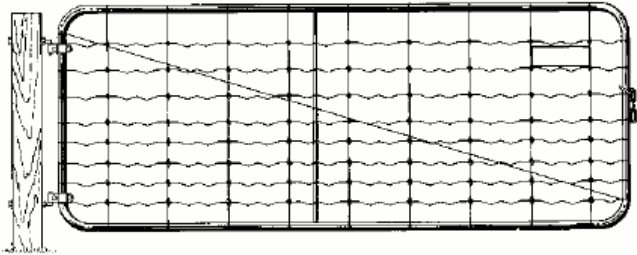
Part Number	Description	Price	
FG10	10' x 48"	238.26	
FG12	12' x 48"	256.50	
FG14	14' x 48"	327.18	
FG16	16' x 48"	348.84	
FG18	18' x 48"	438.90	

Note: Gates up to 16' come with two sets of hinges. 18' gates come with three sets.

Merchant Wire – available in 10lb. and 50lb. coils

Gauge	Price per 10lb.	# ft. per 10lb. coil	Price per 50lb.	# ft. per 50lb. coil
9ga.	15.43	180 ft/coil	72.39	903 ft/coil
12ga.	15.55	346 ft/coil	73.75	1731 ft/coil
14ga.	15.96	585 ft/coil	75.63	2926 ft/coil
16ga.	16.53	914 ft/coil	n/a	n/a

Quik Rok – fast set cement, per 50lb. pail

Net price each				
1-9 pails	10-49 pails	50-99 pails	100+pails	
55.39	49.66	45.84	42.02	

Painted steel T-Posts – punched

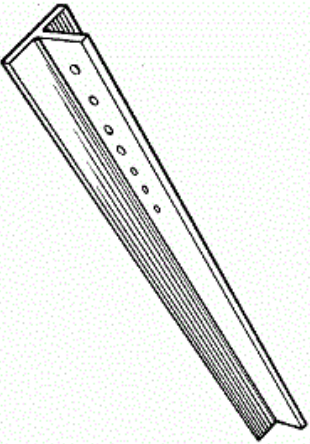
Length	Weight per 100	# in a bundle	Price each		
			Loose	Bundle lot	
Standard weight					
6'	798lbs.	50	9.97	9.07	
7'	931lbs.	50	11.70	10.64	
8'	1064lbs.	50	13.44	12.22	
9'	1197lbs.	50	On Request		
10'	1330lbs.	50	On Request		
Light weight					
6'	678lbs.	50	8.88	8.08	
7'	791lbs.	50	10.61	9.65	
8'	904lbs.	50	12.06	10.97	

Vexar Plastic Fence – 100% Canadian made from recycled resins!

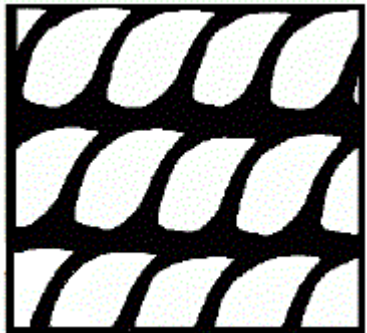

Description	Net price per roll			
	1-9 rolls	10-24 rolls	25+ rolls	
L60 Safety Fence International Orange - 1½" mesh x 48" 50' rolls, 26lbs. per roll	57.36	54.97	52.58	 L60/L70 Safety Fence
L70 Safety Fence/Residential Fence Orange/Green/Black - 2" mesh x 48" 50' rolls, 20lbs. per roll	35.52	34.04	32.56	
L250 Snow Fence International Orange - 48" high 50' rolls, 26lbs. per roll	56.76	54.40	52.03	 L250 Snow Fence
L69 Residential Fence International Orange - 2" mesh x 48" 50' rolls, 15lbs. per roll	32.46	31.10	29.75	

Snow Fence Ties - Galvanized

Size	Weight of bundle	Price per bundle
10" x 14ga.	46lbs	73.98

Description	Price	
T-Post Plastic Caps	.55	 <small>T-Cap</small>

Dog Kennels – Pre-Galvanized Tubing

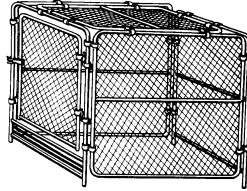

No welding, No drilling holes, Nothing to install!

Manufactured from 1¼" O.D. x 16ga. **Pre-Galvanized tubing**. 2" x 11ga. galvanized fill, including 2 double frame collars per panel. Roof panels come with 8 double frame collars.

Front panels with gate (w x h)		Back panels (w x h)	
Size	Price each	Size	Price each
4' x 72"	291.47	4' x 72"	160.19
6' x 72"	362.16	6' x 72"	177.42
8' x 72"	412.70	8' x 72"	197.25
		10' x 72"	228.63
		12' x 72"	274.35
Side panels (l x h)		Roof panels (w x l)	
6' x 72"	177.42	4' x 72"	160.19
8' x 72"	197.25	6' x 72"	177.42
10' x 72"	228.63	6' x 96"	197.34
12' x 72"	274.35	6' x 120"	227.05
		6' x 144"	270.34
Fittings			
Double frame collars (MF 39)	1.75	Kennel Latch	9.76
		Gate Hinges	4.31
3 Way Clamp	2.17		

48" and 60" heights are also available. Other custom sizes are available upon request.

Iron Eagle Tradition – available in black, white, brown, green. ½" x ½" pickets, 1" x1" rails - (includes universal brackets)

Residential Two Rail system – Elegant Eagle, Imperial Eagle, Majestic Eagle, Royal Eagle

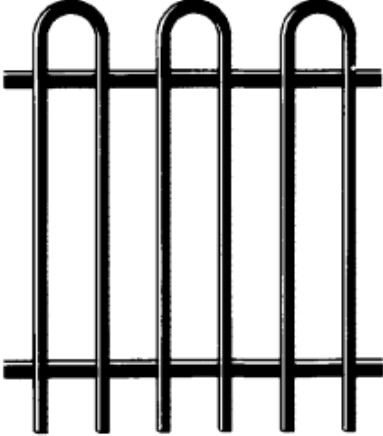
 <p style="text-align: center;">Royal Eagle</p>	Description	Price each
	8' section x 36" high	160.95
	8' section x 48" high	188.97
	8' section x 60" high	216.99
	8' section x 72" high	245.01
	3½' gate x 48" high	167.64
	5' gate x 48" high	193.32
	3½' gate x 60" high	179.43
	5' gate x 60" high	208.51
	3½' gate x 72" high	191.23
5' gate x 72" high	223.70	

Residential Three Rail system – Silver Eagle, American Eagle

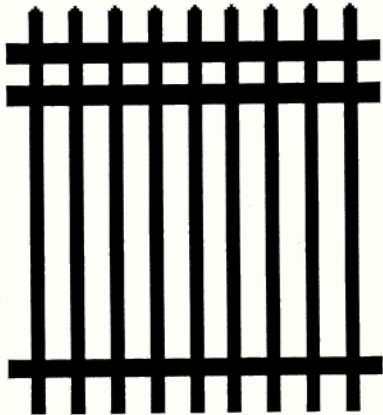
 <p style="text-align: center;">American Eagle</p>	Description	Price each
	8' section x 36" high	190.40
	8' section x 48" high	218.41
	8' section x 60" high	246.43
	8' section x 72" high	274.45
	3½' gate x 48" high	178.53
	5' gate x 48" high	208.62
	3½' gate x 60" high	190.33
	5' gate x 60" high	223.81
	3½' gate x 72" high	202.12
5' gate x 72" high	239.00	

Posts - standard	Description	Price each
	2" square x 7' with pyramid cap	31.03
	2" square x 8' with pyramid cap	35.31
	2" square x 9' with pyramid cap	39.31

Iron Eagle 2000 series – 5/8" x 5/8" pickets, 1" x1" rails. Picket top available in Arrow, maple Leaf or Fleur de Lis – (includes universal brackets)

Residential Two Rail system – 2000, 2020, 2030, 2040 (Rings and Finials extra)

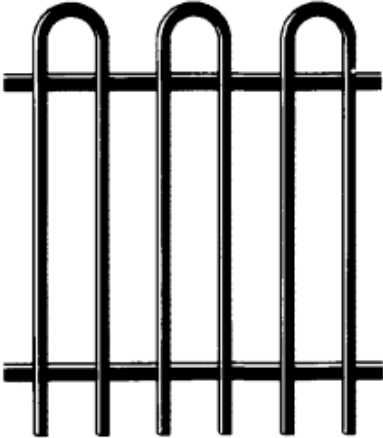

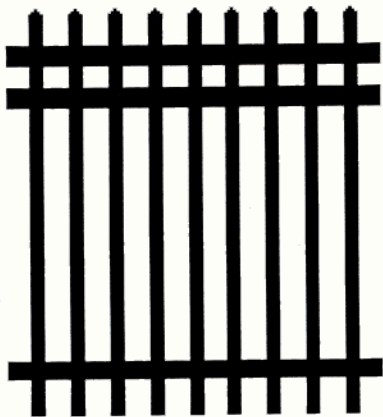

 <p style="text-align: center;">2020</p>	Description	Price each
	8' section x 36" high	177.58
	8' section x 48" high	210.66
	8' section x 60" high	243.74
	8' section x 72" high	276.82
	3½' gate x 48" high	184.25
	5' gate x 48" high	213.75
	3½' gate x 60" high	198.32
	5' gate x 60" high	232.10
	3½' gate x 72" high	212.37
5' gate x 72" high	250.44	

Residential Three Rail system – 2100, 2110, 2140, 2150 (Rings and finials extra)

 <p style="text-align: center;">2100</p>	Description	Price each
	8' section x 36" high	207.53
	8' section x 48" high	240.62
	8' section x 60" high	273.71
	8' section x 72" high	306.78
	3½' gate x 48" high	203.86
	5' gate x 48" high	237.87
	3½' gate x 60" high	217.93
	5' gate x 60" high	256.21
	3½' gate x 72" high	232.00
5' gate x 72" high	274.57	

Posts - standard	Description	Price each
	2" square x 7' with pyramid cap	31.03
	2" square x 8' with pyramid cap	35.31
	2" square x 9' with pyramid cap	39.31

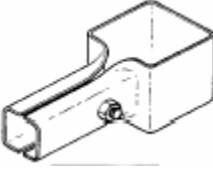
Iron Eagle Tradition and 2000 Series Residential Fittings

Description	Price	Description	Price
2" x 2" End Swivel Bracket 	5.89	2" x 2" Line Swivel Bracket 	9.31
2" x 2" Universal Bracket 	2.66	2" x 2" Line Bracket 	3.85
2" x 2" End Bracket 	3.03	1" x 1" Aluminum Wall Bracket 	2.91
1" x 1" Aluminum Wall Bracket c/w 20 Degree Angle 	3.12	2" x 2" Brace Band 	3.02
		2" x 2" Tension Band 	2.97

Colours:

(HB) High-Gloss Black	(WH) White	(SB) Semi-Gloss Black
(GR) Green	(BR) Brown	(FG) Forest Green
(SP) Special		

Iron Eagle Tradition and 2000 Series Residential Fittings – cont'd.

Description	Price	Description	Price
4 Sided Spire Post Cap 2" x 2" Aluminum 	8.92	4 Sided Acorn Post Cap 2" x 2" Aluminum 	9.48
Pyramid Post Cap 2" x 2" Aluminum 	3.27	Ball Post Cap  <small>2" x 2" Ball Cap</small>	8.17

Colours:

(HB) High-Gloss Black	(WH) White	(SB) Semi-Gloss Black
(GR) Green	(BR) Brown	(FG) Forest Green
(SP) Special		

Iron Eagle Tradition and 2000 Series Residential Gate Fittings

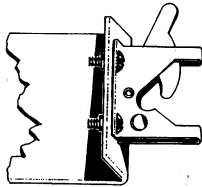
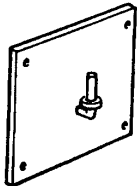
Self Closure (set) 1 – 2" x 2" Post Collar 2 – 1" x 1" Gate Collar 	23.10	Post Collar - 2" - c/w bolt	9.90
		Frame Collar - 1"	5.33
		Latch Catch - 2"	11.99
		Finger Latch - 1"	6.16
		½" x 24" Cane bolt	28.33
Wall Latch c/w Bracket 	8.32	Wall Plate c/w ½" Hinge Bolt 4" x 4" Plate 	15.49

Colours:

(HB) High-Gloss Black	(WH) White	(SB) Semi-Gloss Black
(GR) Green	(BR) Brown	(FG) Forest Green
(SP) Special		

Iron Eagle II – 3/4" x 1 1/2" pickets, 1 1/2" x 2 1/2" rails. Picket top available in Arrow, Maple Leaf or Fleur de Lis (**brackets are extra**)

Industrial Two Rail system – Elegant Eagle II, Imperial Eagle II, Majestic Eagle II, Royal Eagle II





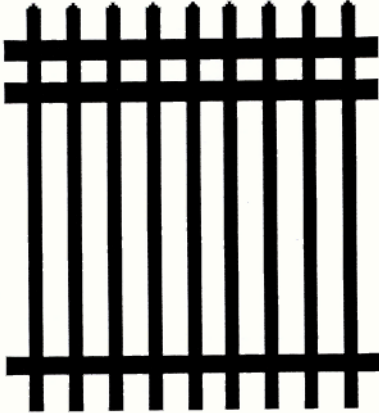

 <p style="text-align: center;">Royal Eagle II</p>	Description	Price each
	8' section x 48" high	334.20
	8' section x 60" high	388.91
	8' section x 72" high	441.64
	3 1/2' gate x 48" high	395.08
	5' gate x 48" high	475.15
	3 1/2' gate x 60" high	431.59
	5' gate x 60" high	524.78
	3 1/2' gate x 72" high	467.14
5' gate x 72" high	572.95	

Industrial Three Rail system – Canadian Eagle II, Royal Elegant II, Silver Eagle II, Golden Eagle II, Majestic Elegant II

 <p style="text-align: center;">Golden Eagle II</p>	Description	Price each
	8' section x 48" high	380.55
	8' section x 60" high	435.26
	8' section x 72" high	487.99
	3 1/2' gate x 48" high	472.93
	5' gate x 48" high	564.11
	3 1/2' gate x 60" high	509.44
	5' gate x 60" high	613.73
	3 1/2' gate x 72" high	544.99
5' gate x 72" high	661.91	

Posts – 14 ga.	Description	Price each
	3" square x 7' with pyramid cap	73.17
	3" square x 8' with pyramid cap	82.77
	3" square x 9' with pyramid cap	92.36

Iron Eagle II Industrial Fittings

Description	Price	Description	Price
3" x 3" Line Bracket 	11.14	Universal Swivel Bracket 	8.91
Universal Bracket End-Line – c/w nut and bolt 		Corner Elevations 3" x 3" Corner Elevations 4" x 4" Corner Elevations 6" x 6"	6.91 9.90 14.36
3" x 3" Aluminum Pyramid Cap 	6.04	3" x 3" Brace Band 4" x 4" Brace band 6" x 6" Brace Band 	3.51 9.67 16.58
		3" x 3" Tension Band 4" x 4" Tension Band 6" x 6" Tension Band 	3.40 8.59 16.58

Colours:

(HB) High-Gloss Black (WH) White (SB) Semi-Gloss Black
 (GR) Green (BR) Brown (FG) Forest Green
 (SP) Special